

THE SPACE GAMER

NUMBER 13

ONE DOLLAR



DEAN MORRISSEY
77

THE SPACE GAMER

NO. 13
SEPTEMBER — OCTOBER

FEATURES

WarpWar: a designer's introduction	Howard Thompson
BACK TO BASICS	Edward C. Cooper
WHEN WINNING HURTS	Robert C. Kirk
A WALK THROUGH DRAGON PASS	Neil Shapiro
BPC SUBS	Martin Halbert
MELEE: New Weapons	Steve Jackson
MEETING TEELA BROWN	Robert C. Kirk
OGRE meets STARSHIP TROOPERS	Mike Lazine
HIT PROBABILITIES IN MELEE	Tracy Harm
SCIENCE FICTION & FANTASY GAMING: Our Own Genre?	Tony Watson

FICTION

FOOL'S CHOICE	Ted Butler	36
ABSOLUTE ZERO	Elrohir & Rahman	34

REVIEWS

CHITIN:I	David James Ritchie	40
BATTLEFLEET MARS	Lynn David Wolpert	42
SPACE MARINES	Lynn Willis	44

COLUMNS

WHERE WERE GOING	Howard Thompson	1
NEWS & PLUGS	Tommye Thompson	28
BOOKS	C. Ben Ostrander	32
DESIGNER'S NOTEBOOK	Steve Jackson	35
LETTERS		45

EDITOR: C. Ben Ostrander

PUBLISHER: Howard Thompson

CONTRIBUTING EDITORS: Steve Jackson, Robert Taylor

COPY EDITOR: Alice Ann Hoef

SUBSCRIPTIONS: Tommye Thompson, Karol Sandberg

ART IN THIS ISSUE

COVER: THE ORC from the game MELEE
by Dean Morrissey
Winchell Chung...pages 5,15,37
Robert Manns...pages 7,8,23,27
Paul Jaquays...pages 9,21,41,43,45,33
Elladan Erohir...pages 12,34
Liz Danforth...pages 17,18,20
Nils Kullander...page 19
StephenLally...page 30
Robert Barger...pages 38,39,46
David Pilleggi...page 44

The Space Gamer is published six times yearly by Metagaming, Box 15346, Austin, Texas 78761. All material copyright © 1977 by *The Space Gamer*. All rights reserved for material accepted for publication unless initially specified and agreed otherwise. News items and product announcements accepted subject to editorial whim. Subscriptions: six issues, \$5; 12 issues, \$9. Base rate for unsolicited manuscripts is one cent per word; manuscripts should be typed on white bond paper and be double-spaced. Base rate for artwork is \$20 per average page size. Art should be on heavy white paper, rendered in black ink. Return postage should accompany art and manuscripts. Second class postage applied for.

WHERE WE'RE GOING

My first thought after absorbing all the new ORIGINS '77 game releases was that science fiction and fantasy gaming has come of age. Every major game publisher now has its foot in the market. Battleline, Game Designer's Workshop, Avalon Hill, Tactical Studies Rules, and Simulations Publications all now have SF&F games; and they all have plans to publish more.

According to Tim Kask of TSR, THE DRAGON's circulation has topped 6,500. That makes it larger than everything but THE GENERAL, MOVES, and STRATEGY AND TACTICS. That's doing pretty good for a SF&F gaming zine. SPI data keeps showing their SF titles as best sellers. The miniatures manufacturers keep coming out with new fantasy figures and finding ready markets. Lou Rocchi finds his Star Fleet ship miniatures selling like hotcakes.

The attention wargaming in general is receiving has a lot to do with this recent growth. National trade publications like TOY AND HOBBY WORLD, MODEL RETAILER, and CRAFT, MODEL AND HOBBY INDUSTRY are making special efforts to expand their hobby coverage of wargaming. Science fiction and fantasy games are getting a particular boost with the public because of the excitement generated by STAR WARS.

Watching all this happen from our vantage point at METAGAMING leaves us a bit breathless. We started with the idea that METAGAMING would be more a large hobby effort that would provide a few of us with a modest living. The rapid hobby growth and huge popularity of our MicroGames may change that. If we grow as much next year as this year, very likely we'll be close to being the third largest board wargaming firm. TSR and Battleline may be ahead of us, but it won't be by much. That's a big jump over our original expectations.

We need to quadruple our office/storage space immediately. We need to buy copiers, typesetting equipment, computers, graphics equipment, and a whole long list of other items to keep up with what's happening. We can't and won't be caught short by the popularity of our products. Since we are buying everything in cash, it takes time.

We'll keep doing what we like and won't be caught short if our popularity out-distances our expectations.

WARPCAR ran three weeks behind schedule getting back from the printer. Much of that time was made up by mailing the games out first class to those customers who had bought before release. RIVETS looks good for about October 20; but, let's say October 31 to allow for foul-ups. WIZARD should be ready about December 1.

Please don't send money yet for THE FANTASY TRIP: IN THE LABYRINTH. We don't have a firm price or publication date set on it. We are looking at no later than February, and will go earlier if it is ready. If it will take some extra weeks and testing to make it better, we'll take that time.

You will notice a shift in our name from METAGAMING CONCEPTS to METAGAMING. This is what everyone calls us, so we're making it official.

The computer project(s) is still lurking in the immediate wings. The order processing staff has let me know in no uncertain terms that orders, subscriptions, and associated record keeping will be the first things to go on computer. Given the work volume, they are absolutely right. One fairly quick bonus of the computer will be MicroGame subscriptions, which so many of you have asked about. The paper work will be possible with the computer, but there will be only "normal" discounts for subscribers. The plan most in favor now would have an eight MicroGame subscription for TSG subscribers at \$20, and at \$25 for non-subscribers. This will probably be a little bonus for TSG subbers because every fourth Micro looks like it may have a \$3.95 price.

THE FANTASY TRIP: IN THE LABYRINTH is likely to be our first boxed game, if current plans hold up. TFT is our major effort to displace D&D as the premier fantasy role game. We think the TFT system will be cleaner and more playable. There will certainly be (WHERE WE'RE GOING is continued on page 33)

WARPWAR: a designer's introduction

by
Howard Thompson

WarpWar represents something of a break from Metagaming's past game design methodology. The biggest effort in producing a new game is to make rules revisions as a game progresses through design development. WarpWar was developed primarily from sketchy design notes, and lots of playtesting. Draft rules weren't even attempted until playtesting had produced a reasonably stable game system. There were still three separate drafts of the rules, but these drafts polished the explanation of a stable game. There was no attempt to draft rules for the numerous intermediate versions of the game.

There are many advantages to this new approach. Rules are always the hardest part, for me anyway. It's far easier, though still hard work, to write rules when you know what you're saying is the 'final play' version. Writing rules for unfinished modules, then revising those rules after playtesting to reflect the new version is for the birds.

At Metagaming, one designer is responsible for a game from initial concept to final production draft. One person is responsible for all planning and testing. He picks everyone's brains and stirs it all into a final cohesive package. The method of finalizing design before writing rules should increase our design productivity. This productivity increase is made possible by having only one person responsible for the entire design process. Game design is enough of an art that game design by team or committee will produce less playable and less cohesive final designs, all else being equal. This is even more true for larger, complex games.

The most pleasing development of WarpWar was the increasing complexity of strategies during playtesting. WarpWar has a bit of the feel of chess. As you gain experience with its simple rules structure, the play relationships become more challenging. The diceless combat system further

adds to the chess flavor. There are many sneaky movement options. Combat tactics also allow broad opportunity for clever gamers. WarpWar offers you numerous chances to beat your opponent because you out think or out guess him.

I'd bet everyone who plays WarpWar will change their mind several times as to what is the 'best' type of ship to build. What is 'best' in ship building depends on you, your opponent, and the course of play.

WarpWar's base concepts are simple. You build ships with Power/Drives, Beams, Screens, Tubes (for firing Missiles) and Missiles. If you build a ship with a Warp Generator, it can move from star to star along Warplines. These Warships can also have Systemship Racks for carrying Systemships. Systemships don't have Warp Generators, can't carry other Systemships, and can't move from star to star under their own power. Systemships are a bit cheaper to build than Warships. Ships are simple, with only two basic types available. Yet, each ship may be built in any manner desired. You expend Build Points to build up ships from the basic components. The variety is endless.

Combat consists of writing an 'order' for each ship on a contested star hex. Power is allocated from the Power/Drive unit to Drives (for ship combat maneuver), Beams, Screens and Tubes (if a Missile is fired). The Warp Generator, Missiles, and Systemship Racks don't need power from the ship's Power/Drive unit to function during combat.

Each ship is also assigned a combat tactic from the Combat Results Table. The Drive allocation difference between target and firing ship, plus their respective tactic, yields the combat result. There are no die rolls.

You win the game by occupying the enemy's base stars. Each player will have one to three base stars at his end of the map. The map portrays a total of twenty

eight stars, many of which are connected by Warplines. The Advanced scenario allows new Build Points each game turn and uses all three base stars for each player. The Learning Scenario and Intermediate Scenario will run 45 to 75 minutes in play. The Advanced Scenario can run 90 minutes to three hours, depending on player skill.

The use of diceless combat and individualized ship building makes Warp-War an excellent 'heads-on' competitive game. We may use it for some convention tournaments in the Texas area. Nothing happens by chance. YOU do it all. You have to out think, out guess, and out maneuver your opponent. It's all up to you.



Warpship W04 broke from warpline 2.4 lt. hours out from Byblos, a K5 orange primary. W04's Screens shimmered momentarily with kinetic discharge due to the warp transit. Ship leader Emil Thaylon received status reports in his command module.

"SS35 dropped and away under power," stated W04's Power co-ordinator.

"Hold SS36 on standby," said Emil. He wanted to retain one of his Systemships as a surprise or for escape as needed.

"Long Perceptors detect two medium mass enemy craft in Byblos II vicinity."

"Accelerate Fusions 84 Max direct toward primary," directed Emil. Best to close with the enemy rapidly.

"All sections combat ready, condition max alert," said the Power co-ordinator.

"Status check Combat Controller's tactical program," said Emil. "Update with current Long and Short Perceptor running link."

The Combat Controller was pre-programmed with mission directives and tactics selected by Emil. The continuous update through Perceptors would give it effective combat command of the ship. Emil liked to draw enemy fire as a standard opening maneuver. The first pass would have W04 Dodging at maximum Drive and Screen settings. SS35 would fire one Missile while standing off, not revealing for the moment that it had two Tubes.

"Long Perceptors identify enemy as two Systemships, no Warpship present."

"Target ships now accelerating 52

our Max toward our position, intersection 10.4 minutes."

"All Crew on station. Damage control 'bots standing by."

Ship chatter crackled continuously in Emil's ear. The crew of 64 humans, 12 androids, 6 cybers, 117 mobile robots and 1 brain link was readying itself for combat. The constant chatter was filtered to Emil on a priority basis. Chatter on all links was fed simultaneously to the Combat Controller for update monitoring.

"Missiles tracking in, 043H/325V.

W04 Screens up. Dodge started."

"SS35 Targeted one Missile incoming.

W04 targeted one Missile incoming."

"SS35 launches Missile D5 at Target 1."

"Incoming Missile W04 D3 by Short Perceptor tracking. Damage control to Starboard aft. Projected hit. Screens 87% prob holding."

The enemy Missile on W04 was a near perfect matching hit, despite W04's maneuvering. Fortunately, Combat Control analyzed the hit as equivalent technology level. The Max Screen powering was sufficient to absorb the vicious energy flare.

Emil quickly tapped in a minor tactical correction for the next pass. SS35 had also survived. Both sides had 'felt out' the data they wanted.



As mentioned, playtesting revealed progressively complex strategies. I'm sure we didn't fully develop all possibilities. Listed here are some of the things we tried. All had some degree of success at some time during playtesting. All would run into problems as opponents learned how to handle each new approach and developed counter measures.

1. The Monster Beam and Screen Warpship. This ship usually took all Build Points a player had available. The philosophy behind it takes advantage of the fact that Missiles are expended in combat, while Beams can be fired over and over. When a sufficiently large Screen was built, smaller ships had a tough time of it. Also, the large Beam could more easily over power weaker Screened ships.

2. The Warpship 'Fighter' Carrier. This is a Warpship with all Power/Drive for movement and Systemship Racks only. It's function is to carry a covey of

Systemships and drop them for combat. The big ship mentioned in number one could fire on only one target at a time with its Beam. The carrier would come in, drop its covey of small, cheap Systemships (they can only fire one Missile each), and then beat it. The big ship would chew up some of the fighters, but is also likely to suffer severe damage from cumulative Missile hits.

3. *Systemship Fighters.* These were developed for use with the Warship carrier. The cheapest version is a Power/Drive of one and one Tube ship that carries a limited supply of Missiles. All it can do is sit still and fire a Missile. But, it is cheap to build and not much loss when destroyed. Several together can make for a nasty opponent.

4. *The Multi-Missile Ship.* After fighter development, Missiles looked very effective. So, it seemed logical to build a ship with a large number of Missile Tubes. This type of ship usually has enough power to do some combat maneuvering, and fire a dangerous bracket of Missiles. It gets a least some hits each combat round. The short coming turned out to be having all your eggs in one basket. Screens have to be down to fire Missiles. This makes a ship vulnerable. The multi-missile ship did prove a viable type, but was subject to damage.

5. *Super Speed Warships.* This is a relatively weapon weak ship that has a lot of Power/Drive. It can zip around the map in a very pesky manner and retreat from combat easily. It does lack punch. But, a clever player can plague an opponent unmercilessly, forcing him to protect his base stars.

6. *The Middle Ground Tactic.* This tactic was developed as a response to the fast Warship threat to rear areas. There are some key stars on Warlines in the middle of the map. A player would place some relatively cheap Systemships on guard on those stars in order to fragment an opponent's maneuvering range. The guard ships would be shot up easily, but could usually inflict some damage. Sometimes an occasional guard ship can catch the speedsters by suprise.



Acrid smoke was hampering Emil's breathing. He switched to suit air even though W04's hull had sustained only minor leakage. Damage reports flowed across the readout in front of him as he moment-

arily ignored the combat chatter. W04 was still in fighting shape despite some heavy damage. Both Systemship Racks had been blown off. The Beam and Screen projector had suffered 50% damage from overloads and hits. The Power/Drive unit was in the best shape with only 27% damage. SS36 had been blown away. A barely functioning SS35 was still throwing an occasional missile at the two damaged enemy ships.

The early phase of the battle had been W04 open full fire with its Beam in the second and third passes, doing target one minor damage. On pass four, W04 had gone to Drive zero with Screens down and dropped SS36, sure to be a surprise to the enemy. Unfortunately, the enemy had chosen pass four to spring its own little surprise. W04 caught with a here-to-fore unfired Beam while Screens were down.

After that, the battle went quickly. With the strongest single ship Emil had managed to inflict a bit more net damage than he'd received. The enemy had been forced to split fire between three targets, one of which was too big to easily damage. W04 and the two Systemships had concentrated on one enemy ship first and reduced its effectiveness. Then they'd turn fire on the other.

"Targets turning for another pass."

"Three Missiles incoming, all on W04."

"Damn," muttered Emil to no one in particular. He'd decided to stop dead again with Screen down to pick up SS35 for its protection. The two enemy Missiles could really hurt him.

"Missiles tracking in. Beam fired, target two."

The whole ship seemed to hold its breath. The two enemy Missiles bore in rapidly. One missed clean but the other hit midship. Emil's command module lost power briefly, while he sweated profusely.

"Damage report. Level three hit sustained. Screens dead."

"Tracking report. Beam direct hit on target two. Target two Screens blown."

That was at least one bright spot. Emil quickly tapped in new tactics. Now was the time to turn and bore in as if no damage had been taken. The enemy knew he was stronger, but not how much.

"Hard around, Max Beam, Attack," ordered Emil. "SS35 fire last two Missiles at target one."

Emil was taking a risk, but he had a hunch target one was out of action, and he wanted to take target one out before the enemy could think the situation through.

"Two Missiles coming in Drives set low."

"Combat Control projects misses."

Emil relaxed. He had them. His Beam would be a dead hit at full power. They hadn't expected him to charge in at full blast. Now to mop up and limp back home.

The key is variety. Tactical variety is wide. You can bluff, threaten, and mislead your opponent. In one play test game I had a ship, my only strong Warship at that point in the game, that was jumped by a multi-tube missile ship. It was pounding me to jelly. Since the combat was on one of my base stars, I didn't want to retreat. Everything was put into the Warship's Drive and Screen for a few combat rounds in an attempt to avoid the Missile damage. It's not easy to avoid four missiles at a time. But, the Warship managed even though the Screens had to absorb a few hits. At that point, the enemy started running low on Missiles. The Warship could start firing back at a ship that now had to have its Screen down to attack and had few Missiles left. In the end my battered Warship held the base, forcing the enemy to retreat for the time being. But, this was only accomplished by being as cowardly as possible for a few combat rounds. If my Warship had tried to slug it out every combat round, it would have been dusted.

Aside from careful ship building and maneuvering, combat is where you directly make or break your game. Each weapon fired either misses or hits the target. A Beam does as much damage as power allocated to it. A Missile does a basic two hits damage. The Target ship's Screen powering is subtracted from the total of all hits the ship receives.

The other major factor is technology. Every four turns of the game represents a new technological level. Improved technology adds to the damage a weapon inflicts and to the damage a Screen absorbs. In the Advanced Scenario, you can save Build Points from turn to turn. There is incen-

tive to delay building so ships with a higher technological level can be built instead. An indirect affect of technology is that it helps offensive ability progressively more than defensive ability. The game will get bloodier as it progresses. This is a desirable side effect in that games tend to be shorter when weapons get relatively more powerful with time.

Another factor in the game is repair and Missile resupply. A ship having fired its stock of Missiles, can be resupplied on a player's base. A ship that has been damaged can also be repaired (to original form). This allows a player to make damaged ships reuseable as needed. But, a ship never improves its technological level, always retaining the level at which it was built. When you repair a ship, you may be putting Build Points into a lower technology.

All in all, I'm very satisfied with WarpWar. If the game is fairly popular, there is likely to be an expanded four player version that will be an impatient man's STELLAR CONQUEST. It may be that the multi-player WarpWar could lend itself to adaptation as the least complex computer game we'd do.

WarpWar's simple, open-ended format will lend itself to variation and adaptation by gamers. One person commented to me that a game like OGRE or WarpWar is unfinished when so many variations and adaptations are possible. I don't agree. I feel we do better by polishing an excellent, playable, basic system, than by developing all possible variations. Gamers delight in doing their own variations so much, I'd rather give them a solid base from which to extrapolate than do it for them.

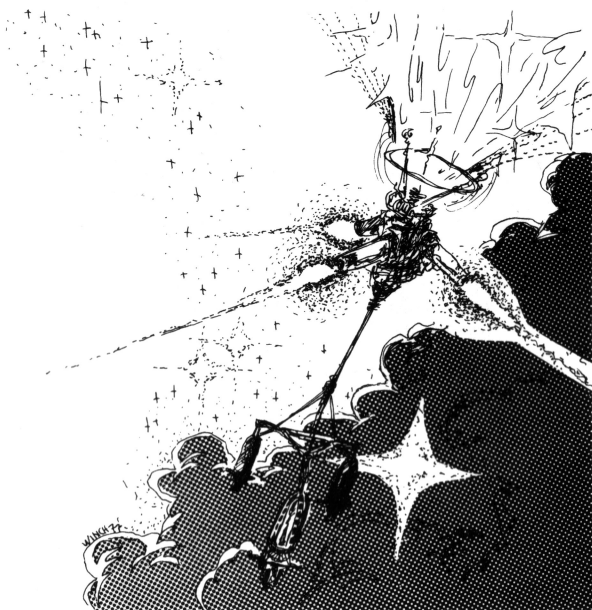

BACK TO BASICS

by

Edward C. Cooper

The analysis of Hymenopteran combat capabilities - more specifically - Hive Combat, is a novel one. Historically, during any one engagement, the Hive who delayed Harvesting ended up the victor. In view of the viciousness and variety of Hive Warriors available, it was a definite handicap to try and oversee an organized harvest at the early point of a battle where numbers were high, and still conduct a successful campaign. The common mistake was to attempt Harvest while the battle's champion was as yet uncertain.

A sudden shift of forces, taking the form of a charge attack by the challenging Hive, and the Harvest Point would suddenly be open to invasion through a broken perimeter. Many Hives lost a tremendous amount of Basics and Workers for this reason in the early phases of Hive warfare on Chelan - Basics and Workers that eventually caused many Hives to cease existence.

A short Harvesting season coupled with harsh winters dominated life on Chelan. Life is a constant competition for survival. Even though population growth rates among the Hymenopterans are high, Hive Mothers do not increase the Hive if food is not sufficient for the winter. This enables more successful Hives to outnumber and overwhelm these starving Hives. Hymenopterans seek space for the Hive to expand as much as they hoard food.

One Hive however, began to finish the battle before attempting the Harvest. The Vox Command Melds suddenly developed the reasoning that the Vlaros would remain present for Harvesting after the battle if all the enemy who could carry it away were destroyed first. There would be no interference with the Harvest. It could be carried out quicker, more efficiently, thus gaining more Vlaros (and nutrients from dead bodies) in the process.

Hive after Hive, immediately beginning to set up a defense umbrella around the Harvest areas, fell before the might of the Vox as their Command Melds, knowing the enemy would exit the battlefield only the way they entered, completely bypassed the Vlaros and sent charging Gantua and Phlanx lumbering into the thinly defended enemy rear. Overrunning many units altogether, hostile Basics were exposed and ruthlessly destroyed. Those remaining units without Command Control became easy prey. The enemy was already cut off from two thirds of the Harvest.

The Vox, by penetrating through the rear, forced their adversaries to lose unit after unit by failing to counterattack. The Vox front formation, now comprised mostly of Low Renders and Termagant, with only a few units of Gantua and Phlanx not in the rear, moved in quickly as the foe was occupied trying to remove the burr in its foot and could not bring to bear the forces which would so easily have punctured this tightening circle. Alien workers undestroyed in the initial overruns, some with Harvest from the closest fields, were prevented from exiting View Plain by the Vox warriors ZOC's.

The advantage of using as many Basics as the Hive could safely spare now proved its worth for the Vox. Detaching the Brothers not needed in Harvest Area Control, a picket line was set up utilizing a Basic, two units of Vox Low Renders, two units of Termagant, and supporting air cover, against enemy workers managing to slip through the ZOC's. The weaker Low Renders, moving best over the rough terrain covering most of Chelan, or the quickness of the Termagant upon the open plains, enabled workers to be overtaken before they exited the battlefield - no matter which direction they turned. Like-

wise, worker replacements entering the battlefield, were prevented from reaching the Harvest area by the same picket line and ZOC's.

Hive combat is clearly structured around the attack. Hymenopteran philosophy dictates attack...attack. Losses are not conceivable. Why should they be? Losses are only another source of food for the Hive! And they make way for other genetic improvements. There is a noticeable lack, to humans, of a Hymenopteran counterpart that is high on defense with low attack caliber. The best defense in Hym terms is a sustained, successful series of attacks. The advantage, illustrated correctly by Chitin: I, is with the attacker - so long as his advance does not falter. All the natural elements of the warriors' armor are for the attack, none solely for the defense...

Harvesting late in the battle prevented undo exposure of weak positions. Geo-

graphical changes in the battleline came slower, could be anticipated, and prepared for. Charge attacks were not as numerous simply because there were not as many surviving units. Command Control could be safely maintained around the Harvest Points. All the factors that had previously forced Basics to split themselves between Harvest and Battle were not present in the Vox system. From this, the secret of winning was to go about the Harvest indirectly - by not trying to Harvest immediately.

This delay of the Vox in Harvesting presents an interesting paradox to Hive logic. In fact, whether the Vox recognized the advantage of delay on a conscience level or not, is debatable. Looking back through the annals of Chelan's history, its hard to say. Some understanding of the concept was there. There is substantial evidence to support the claim that the Vox began the Genetic Revolution with their research, then capitalized on this artificially created "accident" in unifying Chelan under a single Hive.

The dominant trait of the Hymenopterans was undeniably an instinctive urge to obtain as much Vlaros as possible with all speed, regardless of losses. This, of course, is naturally understandable with their concepts of "group" rather than "individual". Loss of the individual meant nothing to the whole in Hymenopteran thinking. Individual loss was not even comprehended or acknowledged. Only achieving the end wished was important.



The failure to consider losses was a vital weakness in the Hymenopteran combat chain, regardless of the fact the dead were used as food. Remember the winters.

A specific example is the legendary Battle of View Plains, whereafter it derived its name. The Kosk Meld of the Tetfra Hive (with serious losses and outnumbered by the Vox ten to one) charge attacked all the same. For the first time, the Vox were caught off guard by this suicide attempt. The maneuver almost turned into a success. The Vox in the immediate area were devastated, yet the Kosk Meld was exterminated in its entirety by the Tetfra Hive the next winter, removing the last major barrier to Vox domination of Chelan.

It must be pointed out, while this weakness will favor an informed opponent in the strategic, it favors the Hymenopteran tactically. There is no question of loyalty or morale "among the troops." There is no panic level. The individual Hymenopteran warrior has no fear of death the idea has no concept or meaning to him. As long as the group lives, all live. Only with the complete and total extermination of the group, will the human sense of death be achieved among the Hymenopterans...

From this, a weakness of the Hymenopterans was found in their greatest strength: the Basic. Elimination of the Basic not only created disruption in the units directly under his command, but an energy lapse in the Meld, as more Brothers broke from the mind web. Rapid deterioration sets in when the mind link becomes strained. The scope of wisdom and flexibility undertaken by six minds together in the Meld surpassed the action pursued by three. (This is also simulated accurately by the Megahexes found in Chitin:1)

The Basics remained the center of control in the Harvest Party, acting as pivot point between command and execution. In the Basics lay the true power and extreme effectiveness of the Hymenopteran combat teams. Ironically, the Basic had no physical defense to speak of and was extremely vulnerable to attacks implemented with surprise and quickness.

Of the winged air creatures native to Chelan, the Plunge showed its true combat potential in seeking out the Basic. Though low in combat strength, the Plunge possessed long range mobility, plus the capacity to operate independently of Command Control - the only warrior capable of doing so. Genetically designed to hamper Basics and the efforts of workers, keeping an opposing Hive off balance, the Plunge represented the first, true strike command with long range. Used in conjunction with charging Gantua or Phlanx, heavy casualties could be inflicted deep into enemy reserves in a matter of minutes.

As a defensive weapon, the Plunge excelled in running air interference on important targets. With claws bred to rip steel, airpower became an important factor in the Harvest, protecting Basics as well as attacking them.

But, the primary effectiveness of the Plunge was undoubtedly as a Basic killer. The safety of the Basic ebbed after releasing a charge attack and sacrificing its Gantua or Phlanx cover. While supporting

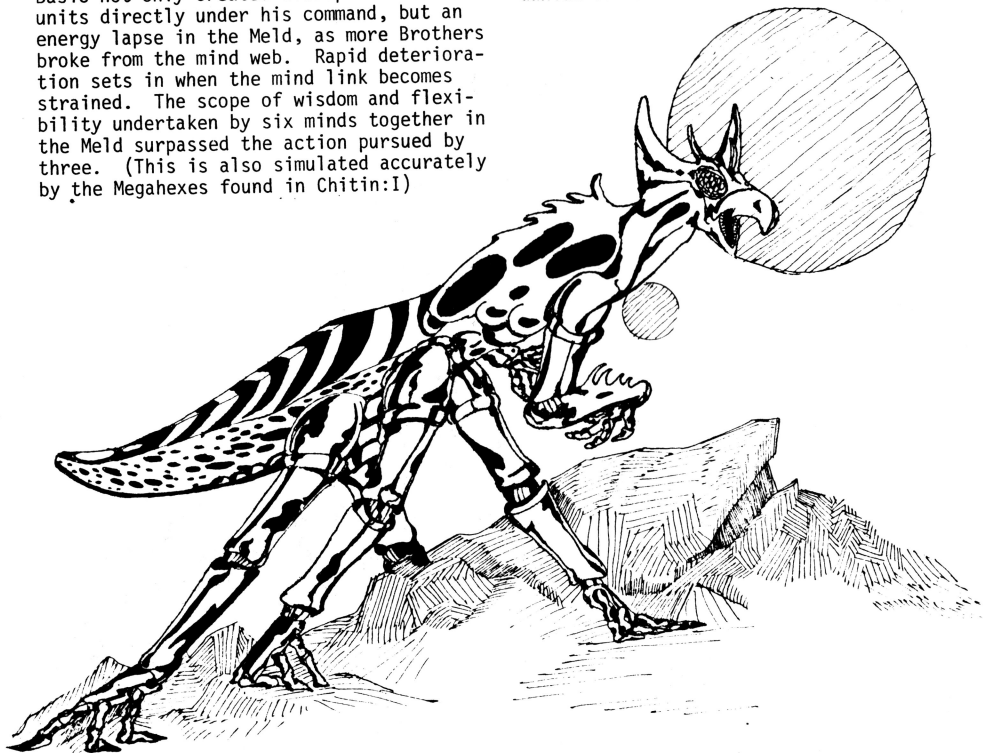

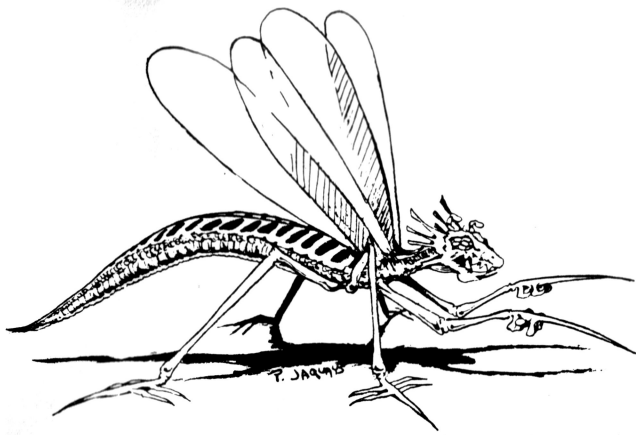

units of Termagant or Low Renders could be moved to cover the Basic, a counter charge attack with combined air strike usually found their target.

Genetic engineering has its limitations. This makes the charge attack of limited use in any prolonged action. The energy needed to charge weakens those same warriors to the point they will surely be lost in the counter attack. Doubt is cast on the long lasting, overall effectiveness of the charge attack in combat use. With the charge you devastate the enemy, but at the price of devastating yourself in return. The Hymenopteran philosophy shows through once again.

A more important factor, often overlooked in measuring the efficiency of Hymenopteran combat - and the battle's victor, was the Terrain. Chelan is a heavily weathered planet with many varied types of terrain. The Hymenopteran warrior was "built" for endurance, conceived for the natural element. It is effective use of the terrain which makes the difference in many Hive battles.

For example, the forests of Chelan are thick and abundant. Basics always use these areas for escaping the typical Plunge counterattack. If nothing else, the Basic knew this forced more Plunge to be concentrated to kill him. This gave his forces a better chance at destroying the Plunge in return - making his price a little higher to the enemy, and insuring there would not be as many Plunge left to take the lives of his brothers.

The classic Vox Picket Line (Low Renders and Termagant) was another systematic advantage, making even the lowest of warriors worth their weight in Vlaros. The streams and mountains in and around the Harvest areas made excellent defense perimeters. They prevented rapid breakthroughs, if not bogging the enemy Hive down entirely.

Hymenopterans are vicious fighters. Humans, in a hypothetical battle, would overwhelmingly have the initial advantage of firepower. Do not misinterpret the Hymenopteran lack of sophisticated weaponry as indicative of intelligence. They

may actually be more sophisticated depending on viewpoint. With the development of their telkinetic ability at its present stage, we may find our own mass production of weapons being used against us rather than the Hymenopterans manufacturing their own. ESP will allow the Melds instant communications and a reactive response time we could only dream of. Both sides will pose problems for the other.

How much the Vox influence will have affected the present philosophy of warfare can only be guessed at. Methods used in Hive war may be completely different from tactics used against men. We don't know how the Hymenopterans themselves view us. Are we a Hive? Up until now, Hymenopterans have not been exposed to outside methods of warfare. And here is a possible human advantage: experience.

Human action against the Hymenopterans, if action is contemplated and peace cannot be achieved, must be swift and successful. Rapid gains must be made to buy time with their own ground. We will surely give much of it back before our technology can discover a means of containing, if not neutralizing, their special abilities. We must fight them on a common level...our best defense is a sustained, successful series of attacks...Hive research is certain to turn once again, back to Basics...

From- A CRITICAL ANALYSIS AND HISTORY OF HYMENOPTERAN WARFARE

Prof. Rafe Marlinson - Ph.D
- Earth University 3127 A.D. -

Prof. Marlinson wearily stopped the vocal-type and removed the last page. Sealing the report, he scribbled across the cover page: "Bill, your training game Chitin: I is good...But is it enough?" He slipped the container into the vacuum tube to his left - the one over which the red letters Dept. of Military Forces stood out prominently. Moving to his window overlooking the University Complex, he glanced at the night and frowned, wondering what light the stars would cast for the future...

WHEN WINNING HURTS

by

Robert C. Kirk

It is somewhat irking to abandon one's prize colonies in the final turns of *Stellar Conquest* to obtain victory points by removing the protective cover of warships to those still uncolonized star hexes. It can even be painful to win when the winner is forced to watch three or four of those abandoned colonies neutralized and conquered by opponents.

It does not provide any relief to know that those two thriving colonies on MINIMAL TERRESTRAL planets with NATURAL METALIZATION are worthless as far as victory goes. This, even though they provide the backbone of the empire's industrial might.

A more equitable method of determining the winner would not be based solely on the "control of the most living space", but would in addition take into consideration economic strength (as determined by the number of population units and industrial output) and military

strength. To begin with, only those planets actually having colonies would count towards victory. It is at best wishful thinking to suppose control of a system by a lone ship, even a dreadnaught, considering the force likely to be encountered in a dispute.

For scoring purposes then, let each colonized Terran-type planet be worth 10 points, each Sub-Terran be worth 7 points, and the Minimal Terran and Barren worth 4 points and 2 points respectively. To this number, add the total industrial unit output (including RIU output) divided by 10. Total the empire's population (ignoring any population still aboard CT's) and, dividing the total by 10, add the result to the total victory points. Finally, for each surviving DN add 2 points to the total and 1 point for each surviving attack ship. SCT's and ESC's do not count. The player with the highest resulting total can justly be designated the winner.

EXAMPLE:

CETI 4	60
TR -80	80/10*
MIRA 3	40
ST -40	40
SIRIUS 2	10
MT -20NM	10/40*
ALCOR 5	70
TR -80	70/30*
CANIS 4	2
TR -60	2

Colony points:

3 colonized TR planets	30
1 colonized ST planet	7
1 colonized MT planet	<u>4</u>
	41

ADD: IU output ÷ 10	33.2
Population ÷ 10	18.2
6 DN's & 11 ATK's	<u>23</u>

TOTAL VICTORY POINTS. . . . 115.4

* RIU's

A WALK THROUGH DRAGON PASS

by
Neil Shapiro

It is my utmost belief that if a reviewer has any prejudice for or against a work it is up to that reviewer to state it up front. So, here it is: I consider WHITE BEAR AND RED MOON to be the very best fantasy game yet published in the field. It was not until I finally set down to ask myself why, exactly, that I discovered the richness, *the true depth of the game*, almost a new dimension to it all. I hope that I may share this discovery with you, the game-player, or at least to give some sort of explanation for a statement that sounds like subjectivity but is, I believe, based within the objectivity of literary criticism.

Yes, LITERARY. In my opinion, WB&RM should be approached not only as a game, as many reviewers have already done, but as a "living" example of the dying Art of Faerie.

According to no less an authority than J.R.R. Tolkien: "To make a Secondary World inside which a green sun will be credible, commanding Secondary Belief, will probably require labor and thought, and will certainly demand a special skill, a kind of elvish craft. Few attempt such difficult tasks. But when they are attempted and in any degree accomplished then we have a rare achievement of Art, indeed narrative art, storymaking in its primary and most potent mode."

We must ask ourselves not whether Cragspider, the Dragonewts or any of the other races in WB&RM are possible as such, but whether or not they conform to all the laws of their own world. We must also find if the laws of the world of Dragon Pass are varied, interesting, and even terrible enough that, in their consistency, they evoke in us images of belief.

In our own world, one may learn that the force of gravity is a constant, an unchanging and mathematically exemplified, everyday power. An advanced student will learn acceleration equations. Everyone, however, can be hit on the head with an apple falling from a height. It is the fact that gravity literally and metaphorically permeates our own universe which lends believability (Tolkien would say Primary Belief) to an otherwise ridiculous idea. (Just think of the absurdity of

dead Earth itself attracting every object for millions of miles in every direction--by no visible means.)

In the world of WB&RM there is no green sun (as far as we yet know) but there is certainly a red moon. This red moon exerts omnipresent, inescapable effects on every other aspect of Dragon Pass. It does so by a means no more visible than the Earth attracts an apple, but it performs its magical functions just as inexorably.

There have been literally dozens of games which have tried to use magic in one form or the other. WB&RM has done more than presented cardboard counters labeled "magicians", it has given to us the concept of magic guided by natural forces of a world. Many of the red moon's images depend on the light of that moon to perform their wonders. Without the light of the red moon they are as helpless, suspended in limbo, as we would be without gravity, suspended in mid-air.

A very nice touch is the Glowline. Here is an area wherein the Cyclical magicians are always at full strength. I do not know if the author of WB&RM intended it or not, but this awakes within me a powerful image. In my mind's eye I can see a world whose red moon never, quite, sets. There is always a blood red, tiny glimmering of that magical light just peering above a mountain lined horizon. Within that everpresent glow, the red moon's conjuror's are complete. Beyond that area, they are dependent upon the time of month, where the red moon is in the sky, and what phase it is in. Should they advance beyond those angling, carmine beams they must do so at their own risk and become ever more mortal in that advance.

The idea of the red moon has been carried throughout the sub-creation of Dragon Pass. Even more importantly, it is integral to both the game and the world encompassing that game.

I have seen other fantasy games which try to throw in any number of ideas as pure atmospheric devices into their back-grounding scenarios. These devices exist only as window dressing, they are useless, they are absurd as they have no function.



The awesome red moon has a function, and that function weaves throughout the mythos of Dragon Pass. I give to it my own Secondary Belief, I will believe in it whenever I travel that world for that world depends upon it.

It is more, much more, than mere atmospheric trapping. In the game, it achieves much the same effect that a red sun did in Jack Vance's novel *THE DYING EARTH*. It is not only a mood setter, it is a *raison d'etre*, upon its presence hinges many other facets of the entire sub-creation.

WB&RM appeals not only to the gamer in Everyman, it has a deeper, more profound call as well. The visitor to the land of red moonlit nights will experience an awakening of unconscious responses to images and ideas, an entire mythos, deeply held within the minds of not only our culture but several others as well. Some would say that a sub-creation such as WB&RM is appealing to deeply held mythical archetypes, that by echoing already unconsciously held beliefs, it reinforces those myths.

Sir James Frazer, in his classic work on mythology, *THE GOLDEN BOUGH*, has shown

that many myths are cross-cultural; they are not Indian, or Egyptian, or Greek, but are simply Human. Certain ones have occurred in all mythologies under various guises. While certain of Frazer's theories, at least the details, have been lately rejected the basic fabric of his work and ideas still hold today.

What is there in Dragon Pass which is familiar?

This question is most important, not only for understanding the appeal of WB&RM but to discover certain methods which may be applied not only to judging other fantasy games, but literature as well.

The idea of the Dragonewt race is a deep one which has a profound effect upon anyone whose mind is the least susceptible to the mythical image. The basic rule regarding dragonewts reads: "Whenever any Dragonewt unit is killed in battle it immediately reappears back to its original city."

One of Frazer's most quoted theories concerns 'Dying and Reviving Gods.' In THE GOLDEN BOUGH, Frazer attempted to relate such myths as Egypt's Osiris, Mesopotamia's Tammuz and many others to a vegetative cycle of renewed life which all human society has recognized, has depended upon for survival, and has tried to codify -- and sometimes influence -- by inventing mythologies of rebirth surrounding this natural process.

Dr. Theodor Gaster in the late Fifties, took Sir James Frazer's GOLDEN BOUGH, abridged it and added notes to it relating to modern scholarship to produce the volume THE NEW GOLDEN BOUGH (Mentor Books, New American Library, New York, NY).

Gaster updates Frazer's theories of vegetative, dying gods by remarking: "Even admitting that these gods are not actual personifications of crops or fruits, it may be doubted whether they are genii or vegetation at all. Far more probably, *they are genii of the community or locality as a whole...* For what is symbolized in such rites is...the rhythm of corporate life in all its manifestations." (I italicized the first line for effect.)

How well the idea of the Dragonewts follows this! It is, in fact, a succinct expression of both Frazer and Gaster's theories -- a veritable melting of the two. The revived Dragonewts appear in their original cities, back in the communities which gave them life. For it was the communities, the cities themselves which parented them and continue to resurrect them. Even the Dragonewt roads connect the Dragonewt cities and help to sustain the corporate life of those cities and help to sustain the corporate life of those cities, to continue the cycle of life.

It is not necessary to read THE NEW GOLDEN BOUGH to appreciate the point I am trying to make. In fact, the less

learned one is in mythology and comparative mythology, the less one will introspectively deny himself the opportunity to appreciate a mythical response.

The Dragonewts are believable because they are directly appropriate to a myth-making force which has been present in so many societies and ages that we must now recognize it as being present in all humans to one degree or another. Obviously, those who enjoy fantasy literature -- or games -- have this in-built response to a marked degree indeed.

To digress for a moment, what is wrong with many other fantasy games? What fault have they that WB&RM has so aptly avoided?

The fact is that many fantasy authors are mistaken in their belief that they should strive for originality. I do not mean originality of presentation, for that is part and parcel of any truly creative process. The problem with much fantasy literature (and I mean games as well) is simply that they have invented mythologies which have absolutely no appeal to this in-built human drive.

It is not my purpose to "pan" any games in this article, so I shall not name the one to which I now refer. It is a well-known fantasy game with many devotees and -- in truth -- it also has many good facets. Yet, it has many terrible flaws. The author has confused originality of presentation with originality of material. Many times he steps from mythology into bathos.

The game offers literally dozens of different races, opponents, rules, mood-setters, etc. Unfortunately, the author invents a number of things which are best described as mythologically unfounded and so are ridiculous and unbelievable. It is one thing to have a dragon, it is quite another to have that dragon spitting a fluid which will dissolve armor.

At first glance a fluid spitting dragon seems no less believable than a race of half-serpent beings who die and are revived. And yet, this is the difference between 'good' fantasy and 'bad.'

The Dragonewts appeal to deep-seated responses within the human psyche. Fluid-spitting dragons are very original, fantastically original, and are thus only fantastic.

Fantastic is not enough.

Fantastic, by itself, is worse than too little.

I submit that everything within the world of Dragon Pass is not only a self-cohesive sub-creation but that it also exists in another world besides that of the game -- the dark, unknown world of the human mind.

WHITE BEAR AND RED MOON is much better than just fantastic.

It is a sub-creation as real as all mythology.

BPC SUBS

by

Martin Halbert

16.00 INTRODUCTION BPC SUBS is a series of rules governing naval battles in sea warfare variants of OGRE.

17.00 SUBMARINES are underwater units which begin hidden, but can be subsequently detected and/or reveal themselves. They have a defense factor of three, a movement factor of two, and a strength/range factor of 6/5.

17.01 SETUP, At the beginning of the game the owning player selects positions for his subs. Counters are not actually placed on the board; players must remember their opening positions until changed.

17.2 DETECTION occurs in four ways. When detection occurs a unit's representative counter is placed on the board.

17.021 When a sub attacks in any way its position is revealed. This condition is not permanent, however. If a sub moves after this type of detection its position may or may not remain revealed depending on 17.022 conditions. If a sub remains motionless after attacking, its position remains known.

17.022 When a sub moves, a die is cast to determine if it is detected. A roll of 1-3 results in detection. A roll of 4-6 and the sub remains hidden. Each time a sub moves a die is cast to determine if it is detected; it is possible to remain hidden throughout the game, or to be found on the first turn.

17.023 When an enemy unit moves adjacent to a sub, the sub is detected.

17.024 When a sub releases decoy torpedoes (see 17.03), its counter is placed on the board inverted.

17.03 To mask its movement, a sub may launch during its movement phase one decoy torpedo. Doing this automatically negates procedure 17.022, but the decision to launch decoy torpedoes must be made BEFORE

movement. A sub cannot first undergo 17.022 and then if it receives a bad result launch decoy torpedoes. A decoy torpedo is expended after the turn in which it was launched and disappears just before its second movement phase. A sub that has launched decoy torpedoes remains inverted until the next movement phase whether or not it attacks or an enemy unit moves adjacent to it (exceptions to 17.021 and 17.023). A decoy torpedo is destroyed by any attack and has no effect on other units.

18.00 Subs attack and are attacked by surface craft in a normal manner. If a sub suffers a disruption result it is considered surfaced and its position is known for as long as the disruption applies.

18.01 A sub may voluntarily surface to bombard coastal targets. A sub attacks at half strength against shore targets. When a sub surfaces it stays surfaced until its next movement phase. Surfacing costs nothing; a sub may surface and also move its full movement allowance.

18.02 When detected, a sub may be attacked by bomber aircraft in a normal manner (considered a depth charge attack). They may be attacked by both bombers AND fighters when surfaced. A sub attacks at half strength against aircraft.

19.00 SEVs are larger versions of GEVs.

19.01 LSEV SEVs have two forms. The first (LSEV) is used for amphibious operations. They can transport: one heavy tank, one missile tank and one platoon of infantry (1/1), or one company of infantry (3/1). They have a defense factor of two, and can move six hexes in a turn. They have no offensive strength. To load or unload they must stay in one place for a full turn. The unloaded units can move and attack after this, or the loaded LSEVs may move off.

19.02 SESs In their second form (SES) SEVS serve as fast destroyer sized ships. They have a defense of four. They move similarly to GEVs. They have one main battery (4/3), and two missiles (6/5). These do not have individual defense factors as the weapons on an Ogre do. When a SES is attacked, all its weapons undergo the attack. If it receives a "destroyed" result all the weapons are destroyed along with the ship.

19.03 (Optional) The SES can also carry a small hovercopter. It has no attack or defense strength. Its purpose is to search for subs. A hovercopter can detect a sub if it is in the same hex at the end of the hovercopter's movement phase. The hovercopter has a movement allowance of 12.

20.00 THE SEA CONTROL SHIP is a sea-going platform. It can serve as a small aircraft carrier in battle. It can launch four fighters in a game; one at a time, or all at once. It can also launch four hovercopters in a game. The SCS has a defense of two, a movement factor of two, and no attack strength.

21.00 WATER MOVEMENT GEVs, SEVs, and SC ships can move on the surface of the water (also surfaced subs). Neither subs nor SC ships may move into land hexes. Ogres can move on land and water (see 21.01). Aircraft may move into (over) water areas. No other units may move into water hexes.

21.01 Ogres may move along the sea floor at a cost of +1 movement. This means that to begin with the Ogre can only move two hexes at a time (2 + 1). When an Ogre's

movement drops to 1 he cannot move at all. The only weapons they may use then are their missiles, which they use normally. They begin play hidden similar to subs, but do not reveal themselves by movement. Once they have fired a missile they are revealed and stay revealed. When an Ogre's movement points are attacked while underwater they are attacked at 2-1 odds.

21.02 Only one submerged unit may occupy a given water hex (exception: Two enemy underwater units may pass through the same hex if neither have been detected). A surface unit and a submerged unit may occupy the same hex and attack each other. Surfaced subs may occupy the same hex as submerged subs, but not with surface ships.

22.00 MAP Obviously the OGRE map, as it stands cannot be used for sea battles. A simple scenario can be constructed by treating clear hexes as water hexes, craters and obstructed hexsides as coral and impassible to subs. The last row of hexes should be treated as the shore and the objective of an invading player. Howitzer batteries can be set up on the crater/island hexes as shore defense. Interesting amphibious invasion battles can be invented with LSEVs and Ogres. A 'wolf-pack' scenario with convoy vs. subs can be made ignoring all terrain. Imagination is the limit.

22.01 Mined areas are predesignated sections that are considered mined with proximity explosives. When a surface craft or sub passes through a mined area they immediately undergo a 1-1 attack. Special minelaying subs and SEVs can 'mine' a hex by spending three consecutive turns there inactive.

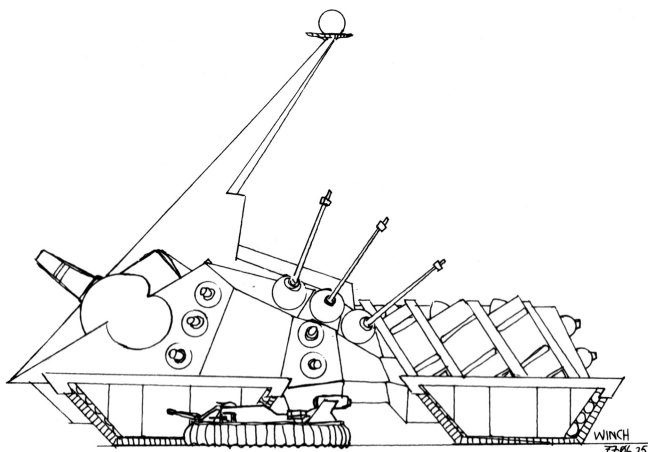

MELEE: NEW WEAPONS

by
Steve Jackson

MELEE has been out for a few months now, and response has been very good. Thank you - I'm pleased. I've received a number of letters and questions; first, I'd like to answer some of them.

Yes. No. Are you kidding? Of course. If he wants to. Absolutely not! Good question. You're right..wish I'd thought of that. No. No. No, you idiot. Yes. Read page 8 again. No. Wait for WIZARD. Yes. Why not? I don't understand the question. Yes. No. So what?

Sorry, gang. I had to get that out of my system.

OK. Yes, it is possible for an archer to pick the "fire missile weapons" option, and then have all potential targets move out of the area into which he can fire. That's his tough luck. He can just save the arrow...he doesn't actually have to fire at thin air.

Yes, it would have been possible to give your ENEMY a DX add when you took a serious injury, rather than giving you a DX-. It just so happened we did it the other way. Either one would be about as good...I just worked in terms of subtraction whenever possible.

Yes...a figure engaged with several enemy can enter HTH combat with one of them. The others still get a chance to strike before the single figure moves IF their DX is higher, since the move-and-attack-HTH action comes in the regular attack sequence.

If they're adjacent to the hex the figure moved into for HTH combat, they'll be able to strike AFTER the move if their DX is LOWER than that of the attacking figure.

Yes...a figure which moved half (or less) its MA can attack a figure which moved next to it.

Scale: The small hexes are a meter across, which makes the megahexes almost exactly 10 feet. A turn represents about 5 seconds of time.

I'm aware that some weapons can't be used in close quarters. MELEE solved this

by leaving out close-quarter combat situations. THE FANTASY TRIP will have a rule limiting pole weapons on tight tunnels, et cetera.

I'm also aware that some longbows take less strength than some short bows, and that sometimes a rapier can do more damage than a broadsword. However, for game purposes, I ignored these things, and will continue to ignore them...I can't see that a "puny longbow" rule adds any play value. What it DOES add is complexity. Ditto for similar complaints. If you're strong enough for a longbow, take a longbow and play it as a longbow...and if you want to tell yourself it's really a very heavy short bow, go ahead. But don't ask for a D & D-style table about it.

As most of you no doubt realize, the PRIMARY purpose of the weapons table was to give a gradient of weaponry vs strength, so stronger characters could take bigger weapons. Within this constraint, we tried to keep the weapon strength historically accurate...but playability came first. If you want to make up your own weapons, go ahead...but keep the damage they do proportionate to damage done by existing weapons requiring about the same strength. Do that, and you'll have no problems at all...as a matter of fact, feel free to write about them.

One of the most annoying things about MELEE, to me was the space problem. There were a NUMBER of things that I wanted to get in, but didn't have room for. A shield-rush rule, for instance - and rules for the use of net and trident. Anyway, here they are, along with some more material:

Six new "Weird Weapons."

Two new special combat rules: "Shield Rush" and "Dagger Marksmanship."

One new beastie: the Octopus.

And one rule clarification - which I've already mentioned, but will repeat because it's important.

WEIRD WEAPONS

BOLA

In the right hands, the bola can be formidable. Two, three, or four weights are fastened together with thongs. The bola is whirled around one's head and thrown to entangle game - or an enemy.

The bola requires ST of 9. It is treated like a thrown weapon, with the following additional rules:

Before the user throws the bola, he must announce who it is being thrown at, and what the target is: legs, arms, wings, or head. Each target (if the bola hits) produces a different result, as follows:

LEGS: If the bola hits, it will trip the enemy. He will immediately fall down, and will NOT be able to stand the next turn. The turn after that, he WILL be able to stand.

ARMS: If the bola hits, the bola will drop his/her weapon(s), and will not be able to pick them up for the next TWO turns, while his/her arms are tangled. The entangled individual may move normally.

WINGS: If the bola hits the wings of a flying creature, it will cause it to fall (taking one die of damage). If the flying creature has EITHER hands OR a ST greater than 20, it will be able to stand on the next turn, and take off on the turn after that. Otherwise, it will remain grounded, but will be able to stand on the next turn, and move and fight on the ground thereafter.

NOTE: ANY attack on a flying creature (except a magical attack) is at a DX adjustment of -4. Fliers are hard to hit.

HEAD AND NECK: A bola which hits the head and neck does 1 + 2 damage, due to strangulation and weights hitting the head. However, this is a hard target. DX -4 if the bola user throws at the head. A head/neck hit on a flier also brings it down, just like a wing hit. A figure hit on the head/neck with a bola may not attack on his/her next turn (one hand is loosening the new necktie), but may move normally.

If a bola misses its target and its path takes it through another occupied hex, it is assumed to be going at the LEGS of the new target figure.

NET AND TRIDENT

The Roman gladiators, known as "retarii", used this combination. It takes an ST of at least 10 to use net and trident.

The net is held in one hand, the trident in the other; thus, a figure with net and trident ready cannot have a ready shield. (For purposes of choosing weapons, the net counts as one and the trident as one.) As long as the retarius keeps BOTH net and trident ready, he can use both as weapons, but his DX is -4. He can put up one in order to use the other at normal DX.

When both are ready at once, both can be used to attack on the same turn, as long as the same figure is attacked (remember, DX -4), just as though a main-gauche and sword were being used.

The trident is a pole weapon, and does 1 die of damage. The net is barbed, and can be swung to do 1 - 3 damage.

Either the net or the trident can be thrown. Include the -4 DX if both were ready on the turn when one is thrown. They CANNOT be thrown simultaneously; nor can the retarius attack with one on the turn in which he throws the other. The trident is treated like any other thrown weapon. The net is treated like a thrown weapon, EXCEPT that, if it hits, it:

- (a) does its regular 1-3 damage;
- (b) entangles the target, causing him/her to fall. In order to stand up next turn, the target must roll his adjDX on 3 dice. If he fails to make that DX roll, he lies there another turn, and takes another 1-3 damage...and so on, every turn, until he can make the roll to stand.

The retarius' standard tactic is to entangle his enemy, then charge with the trident. When fighting retarii, some gladiators would try to cut up the net before it was thrown. If you have an edged weapon, you may strike at the net instead of the net-wielder. The net (obviously) has no armor, and when it takes 5 hits it is useless.

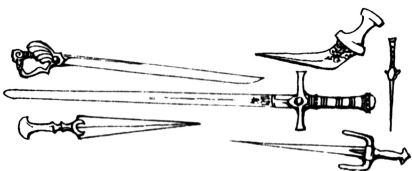

SHA-KEN

Sha-ken, or throwing stars, are an Oriental weapon. A sha-ken, a small barbed or spiked disk, is meant to be thrown at enemies.

A figure of any strength can use throwing stars. Three can be carried in-

stead of a dagger, or a pouch of 15 can be carried instead of one weapon.

A throwing star does 1-2 damage when it hits.

Throwing stars have two advantages: first, a master can throw them with great accuracy, like a dagger (see DAGGER marksmanship in this article); second, several can be thrown at once.

Up to 12 sha-ken can be thrown at once (at the same target). Dexterity adjustments for throwing several sha-ken at once are as follows:

One at a time. no DX adjustment.

Two or three at a time: DX -2.

4, 5, or 6 at a time: DX -4.

7, 8, or 9 at a time: DX -6.

10, 11, or 12 at a time: DX -8.

When several throwing stars are used at once, each one is rolled for separately. All are assumed to be following the same line, for purposes of rolling to see if they hit other figures after missing the intended target. All are readied at once.

Obviously, most people will miss if they use a whole handful of sha-ken...but a high-DX figure can be deadly with them.



TORCH

A torch is often used as an emergency weapon. Against most foes, it does 1-1 damage.

Against a flammable being (like a mummy, or certain slimes), or an aquatic or soft bodied one (like a water elemental, a giant toad, an octopus, etc.), a torch does 1+2 damage.

Against a stony or fiery foe (like a gargoyle, earth or fire elemental, Balrog, etc.), a torch does only 1-3 damage, since it is then effective only as a weak club.

A torch mounted on a long pole is a 1+2 weapon against flammable or aquatic foes, but no good at all against other enemies.

An ordinary animal attacked with a torch will fight at -2 DX due to fear of the flame and will not initiate HTH combat.

If you are in a dark place and fighting with a torch in one hand, a weapon in the other, your DX is -2 if you are just holding the torch, and -6 if you are trying to hit with both the torch and the real weapon on the same turn.

We normally assume that torches are high-quality goods and stay lit until intentionally extinguished. Some GMs prefer to deprive players of their torches at any opportunity. In this case, assume there is a 50% chance that a torch will go out when it hits. An unlit torch is 1-3 weapon.



CESTUS

The cestus is a spiked gauntlet, strapped onto a fighter's hand. A single cestus is treated exactly like a main-gauche, except that, being fastened on, it is always ready and cannot be dropped, either accidentally or intentionally, during combat. A fighter cannot hold a shield or other weapon in a hand bearing a cestus. A single cestus does 1 + 2 during HTH.

A fighter may wear TWO cesti - one on each hand. In that case, he "boxes" with them (this is how the Romans used them). He may attempt to hit with both, each turn. His DX is -3. Each cestus does 1 die damage, or 1 + 2 in HTH combat, when two are worn. Each stops 1 hit in regular (but not HTH) combat. Min ST is 10 for the cestus.

QUARTERSTAFF

Famed as the secondary weapon of Robin Hood and his Merry Men, the quarterstaff is easy to use but hard to master.

As a regular weapon, the quarterstaff requires an ST of 11 and does 1+2 damage.

The quarterstaff may also be used to (attempt to) disarm an opponent. At a DX adjustment of -4, a quarterstaff user may strike at a foe's WEAPON. If he hits, the foe must then make his own adjDX roll. If he misses the roll, he drops the weapon.

TWO NEW COMBAT RULES

SHIELD RUSH

DAGGER MARKSMANSHIP

A very dexterous (or very lucky) individual can throw daggers (or throwing stars) with such great accuracy that they do much more damage than normal. This rule simulates that ability.

An "accurate" throw may be attempted with a single dagger or a single throwing star, as follows:

HEAD. A throw at the head may be attempted if the target is three hexes away or closer. The throw is made at a DX adjustment of -6. If it strikes, the target's armor does NOT protect (the dagger went in through the faceguard), and the dagger (or throwing star) does DOUBLE damage. Incidentally, all doublings are cumulative. If a dagger is thrown at the head, and the "to hit" roll is 4 (also double damage), then the dagger does quadruple damage.

HAND. A throw at either hand may be attempted if the target is three hexes away or closer. The throw is made at a DX adjustment of -4. If it strikes, the dagger (or throwing star) does normal damage, and the target drops the weapon (or shield) that was held in that hand. Armor does not protect against a throw at the hand.

The "shield-rush" (charging at your enemy with your shield forward in an attempt to bowl him over) is an important tactic in some kinds of combat.

The shield-rush is considered an AT-TACK for all purposes; that is, you can strike with the shield after a charge-attack (option b) or a shift-and-attack (option h).

In order to make a shield-rush, you must have a shield ready, and you MUST be as strong as, or stronger than, the foe you are rushing. (Basic ST, not wounded ST, is considered)

When you make a shield-rush, roll as normal when your turn to attack comes. If you fail to make your "to hit" roll, nothing happens. You banged him with your shield, and he took it. If you make your roll, he must then roll his adjDX on 3 dice - that is, make a saving roll. If he makes his adjDX roll, he keeps his feet (he staggered, but did not fall). If he misses the roll, he immediately falls down.

It is quite possible for two figures to shield-rush each other at the same time. Treat this like any other pair of attacks - roll for the one with higher DX first, and then for the other one (if he's still on his feet.)

A shield-rush puts no hits on an enemy.

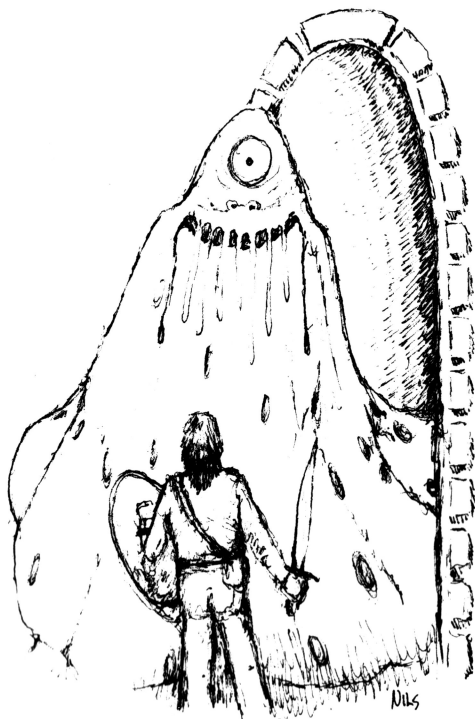

THE OCTOPUS

This is an intelligent being, looking physically very much like the ordinary Earth octopus but with some dangerous differences.

Suggested ST = 20; DX = 15; MA = 8. Its leathery skin stops 2 hits.

The octopus lives underwater or in swampy places, but can and will come on land. It walks upright on 4 or 5 of its 8 legs, standing over 2 meters tall. It can use 3 arms at once for weapons, at NO DX-; thus, an octopus could fight with 3 swords at once, or a two-handed sword and shield, or even a crossbow and shield. It cannot use more than 3 arms for weapons. It CAN attack different enemy with different weapons on the same turn.

An octopus will NOT use daggers in HTH combat, for fear of hurting itself (eight arms are hard to keep track of...). It fights HTH weaponless, and does 1+2 damage when it hits.

Because of an octopus' wide-set eyes

and multiple arms, its side hexes count as front hexes, and its rear hex counts as a side hex. You can't get "behind" it.

Also, since it fights with three arms at once, it can combine combat options in a way that humans can't. It can "defend" (option i) with one weapon while using others to attack with; thus, it can both defend (making itself harder to hit) and attack simultaneously. Also, if it has a weapon to defend with, it does NOT have to drop a missile weapon when engaged; it can reload and reuse the missile weapon IF it goes on the defensive with another weapon at the same time.

The best way to fight an octopus is to outnumber it by at least 3 to 1.

Octopi are greedy, dishonest, and cowardly. They like treasure and human flesh, and will attack to get either. They do NOT enjoy danger, and will run when the going is tough. They prefer ambushes and sneak attacks. They are not common; rarely will you find more than one or two in any place near human habitations.



RULE CLARIFICATION

In answer to a question that has risen a few times: In MELEE, a figure which moves half (or less) of its MA CAN attack an adjacent figure in the combat phase, even if that player did not specifically say he was picking an attack option. If you move half (or less) of your MA, and another figure moves adjacent to you to attack, you may "retroactively" say you are taking an attack option. This is the same as picking an attack option and moving into an empty area, knowing that someone is running out there to fight you...so moving first does NOT deprive you of the chance to fight.

MEETING TEELA BROWN

by
Robert C. Kirk



MONSTER! MONSTERS! is, of course, Metagamings's fantasy role playing game which gives the monsters the opportunity and the incentive to wade out of their dark, dank holes and strike back. Instead of designing a hero to explore dungeons, each player creates monsters whose aim is ravaging the human's towns. They even receive bonus points for monstrous act above and beyond the call of duty.

However, not all monsters have to be huge and ugly. The purpose of this article is to introduce Teela Brown, a twenty-year-old, blond headed girl of delicate beauty with long, perfect legs. She is a major character in Larry Niven's novel, RINGWORLD. If you haven't read it, now is the time.

Teela doesn't sound monstrous, but let's take a look at her prime attributes:

STRENGTH . . .	9
INTELLIGENCE .	16
CONSTITUTION .	14
DEXTERITY . . .	14
LUCK	∞
CHARISMA . . .	18

The only attribute which could be considered unusual for a well-

educated young lady is, of course, her luck factor, which is infinite. Her ancestors for the last five generations were winner's of Earth's Birthright Lotteries - an experiment initiated by the Pierson puppeteers to breed humans for luck. The success of their experiment, and the consequences, were beyond their imagining. The result was Teela Brown. (Please read RINGWORLD You will be astounded.)

A Gamemaster can have a lot of fun with Teela Brown in the scenario. Just having her stroll through a village would create all sorts of unlikely consequences--events will conspire to attain a state of maximum advantage for Teela Brown. She does not have to be conscious that it is to her advantage, either. A mugger minding his own business two miles away could be struck by a meteorite so that he will never approach Teela closely enough for her to notice the offensive odor of his unwashed body.

It also possible that she could be held prisoner, necessitating the timely arrival of a wealthy prince to rescue her.

Teela shouldn't appear more than once in any game/universe; but imagine the chaos that one time your players do encounter her...

OGRE meets STARSHIP TROOPERS (or, "Pardon me, but your treads are on my neck...")

by
Mike Lazich

As has probably been noticed by many people, OGRE is a very adaptable game. It is so adaptable that its game system can be integrated with other tactical games, most notably STARSHIP TROOPERS by Avalon Hill. This article attempts to give a system whereby the two games can be tied together with a minimum of difficulty.

The major problem with STARSHIP TROOPERS is the lack of vehicles (the Humanoid and Arachnid Heavy Weapons don't offer enough variety for my taste). Of course, it can be argued that with M.I. in powered armor suits, moving at 30 miles an hour, and carrying nuclear rockets, there is

hardly a need for vehicles. But for those of us who like tanks and armored vehicles (and the idea of Ogres) STARSHIP TROOPERS lacks a little something. After having my last nuke-carrying trooper burned by one of those Heavy Weapons once to often, I now seek revenge...

All the units in OGRE can be used in STARSHIP TROOPERS (with the exceptions of Infantry and CPs) with basic modifications. Due to the difference in scales between the two games, changes in attack strength, defense strength, range, and movement are called for. The new values for the various units are below:

OGRES:

MSL TANK
M4 D6
9/8

HVY TANK
M4 D9
12/4

G.E.V.
M8 D6
6/4

HOWITZER
MO D3
18/12

MARK III (MA:6)
2 MSL (NUC/10; D6) 00
1 MB (12/6; D12) 0
4 2B 9/4; D9 0000
*8 AP (2/1; D2) 00000000
48 MP
00000000 MA 5
00000000 MA 4
00000000 MA 3
00000000 MA 2
00000000 MA 1
00000000 MA 0

MARK V (MA:6)
6 MSL (NUC/10; D6) 000000
2 MB (12/6; D12) 00
6 2B (9/4; D9) 000000
*12 AP (2/1; D2) 000000000000
60 MP
0000000000 MA 5
0000000000 MA 4
0000000000 MA 3
0000000000 MA 2
0000000000 MA 1
0000000000 MA 0

* GOOD AGAINST INFANTRY (M.I., Skinnies, Arachnids) ONLY.

In figuring out the attack and defense strengths of the units, I compared them to the individual M.I., while considering their relative strengths in OGRE. As originally given in OGRE, the values are much too weak to use in STARSHIP TROOPERS. Using the comparisons I was able to get a basic minimum strength. I modified this further by comparing these strengths to the STARSHIP TROOPERS Heavy Weapon strengths.

Movement was figured by using the speed of the Ogre. In "Notes on the Ogre," by Steve Jackson, TSG 9, it stated that the Ogre moves at 45 kilometers per hour or thereabouts. Knowing this, it is a simple matter to convert to miles per hour, and then hexes per turn (actually, as used in STARSHIP TROOPERS, the Ogre moves at 48 kph, but since the terrain isn't as rough, this is justifiable). Other movement rates were figured using their ratio to Ogre movement. It should be noted that here, as in OGRE, G.E.V.s move twice per turn, using their full movement allowance both times.

Ranges for the weapon systems were somewhat of a problem. I finally decided to just double the ranges, and after playing out several combat situations, these

ranges seemed suitable. (The Howitzers were given a range of only 12 instead of 16 hexes, because at a 16 hex range they become too invulnerable.)

As far as the Ogres go, about the only thing that may make people apprehensive about using them is the fact that the missiles on them are considered to be nukes which devastate their target hex. Originally I tried an attack strength of 18. But this did not give the Ogres the devastating power that they have in OGRE. By using nuclear missiles, Ogres become something to be feared again.

Of course an Ogre also fires nuclear shells from its guns. But using nuclear shells in the game tends to make the game unbalanced; it becomes a slaughter.

It was also necessary to adapt the number of movement points of a Mark III Ogre, but this has little effect on play.

RULE CHANGES

OGRE RULEBOOK:

Changes in Movement; 5.02 Ogres and Armor Vehicles do not count in stacking limitations. However, no more than two Ogres and/or Armor units may stack in the same hex, and if this stacking limit is

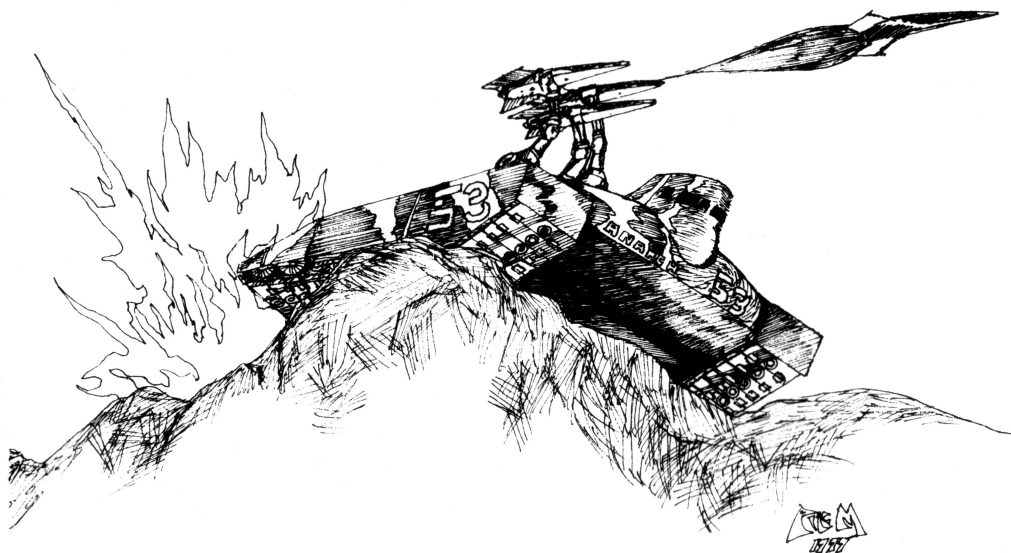

reached, no other units whatsoever may stack in that hex.

If there is an Ogre or armor unit in the hex, it cannot be hidden, and the enemy player(s) must be notified.

Skinny and Archnid Heavy Weapons are not considered armor units in the above instances.

5.031 Skinny and Arachnid Heavy Weapons are considered armor units for ramming purposes.

5.04 When an Ogre overruns infantry (M.I., Skinnies, Arachnids) an attack is made at 2 to 1 odds on the appropriate CRT. These odds remain the same whenever an Ogre overruns infantry and are resolved as ranged combats (see STARSHIP TROOPERS rulebook).

All other movement rules for armor units (Ogres, tanks, etc.) remain as stated in the OGRE rulebook.

Changes in Combat; 6.102 Ogre missiles are given more power when used in STARSHIP TROOPERS. As stated before, they are considered to be nuclear missiles and as such, affect their target hex and adjacent hexes according to the rules on nuclear missiles in the STARSHIP TROOPERS rulebook. Therefore when launching these missiles, consult the STARSHIP TROOPERS rulebook.

All other combat rules for armor units remain as stated in the OGRE rulebook.

STARSHIP TROOPERS RULEBOOK:

Turn Sequence: The turn sequence, when Ogres and armor units are used, is the same as that on page 6. All Ogre and armor unit combat is resolved as ranged weapon combat. G.E.V.s move the second half of their movement allowance during the extended jump phase of the game turn. No other vehicles may perform movement during the extended jump phase.

Nuclear SW&G:

M.I. Nuclear Rocket Launchers: Rules pertaining to these devices remain as stated in the rulebook. However, Ogre missiles are equivalent to nuclear rockets and combat resolution is therefore the same as that of M.I. nuclear rockets.

When attacking an Ogre with nuclear missiles fired from other Ogres of M.I., an attack strength of 24 is applied to any one Ogre weapon or its treads. Ogres adjacent to the nuke detonation hex are unaffected. NOTE: ALL units other than Ogres in the detonation hex and surrounding hexes undergo standard nuclear attack procedure.

Example: An Ogre, stacked with a squad of friendly M.I. and with another squad in an adjacent hex, is attacked by an enemy Ogre missile. The first Ogre is attacked with a strength of 24, while the squad stacked with it is destroyed and a RAD

marker placed in the hex. The squad adjacent to the target Ogre is attacked with an attack strength of 6 using ranged combat resolution.

All combats against Ogre weapons and armor units are resolved on the Terran combat results table of STARSHIP TROOPERS. The table is close enough to the OGRE CRT to be equivalent.

Arachnid Demolition Munitions:

HE DEMOLITIONS: Ogres on surface above detonation hex are unaffected. ALL other units undergo normal effects of HE detonation.

NUC DEMOLITIONS: These affect Ogres in the same manner as nuclear missiles. That is, an attack strength of 24 is applied to any one Ogre weapon or its treads. ALL units other than Ogres undergo normal effects of nuclear detonation.

Nuclear weapons detonated in the same hex as an Ogre do not detonate any of its missiles or other weapons.

RAD Hexes: RAD hexes have no effect whatsoever on Ogre or armor units. They may move freely through these hexes. Skinny and Arachnid Heavy Weapons are not considered armor units in this instance.

MISCELLANEOUS RULES: No vehicles may enter Arachnid tunnel systems. Ogres and armor units must soft land on planetary surfaces.

With these fairly basic rule changes, OGRE fits neatly into the STARSHIP TROOPERS game system.

But how can Ogres and tanks be used in STARSHIP TROOPERS? They can be used to replace equivalent point strengths of M.I. in the various scenarios. A single Ogre Mark V could replace an entire platoon of M.I. and still survive in a relatively decent condition. Two Mark V's, one platoon of M.I., and one platoon of C.E. could fight the defenders of Klen-dathu in "The Last Battle" with little difference in the outcome. Also, the Skinnies, in their scenarios, are too weak. How about beefing up their defense with a Mark III Ogre? Or some MSL TANKS? Or a couple of HVY TANKS? The possibilities are endless.

Some people may be turned off by this addition to STARSHIP TROOPERS, saying the Ogres and vehicles are too powerful, turning the balanced scenarios into wholesale slaughter. The only way to prevent this is to use discretion in deployment. Experimentation will develop balanced scenarios in the end. Meanwhile, the addition of new vehicles to STARSHIP TROOPERS will hopefully provide a new scope of enjoyment for all Ogre fans.

HIT PROBABILITIES IN MELEE

by

Tracy Harms

You hesitate before the arena gate, eyeing the shield weighing heavily on your arm. Can you afford the agility you will lose to the protection you will gain? Alas, there is not time to scratch figures in the dust with your dagger (besides, it's not in the list of options), for you enemy's wailing morningstar approaches. So you hold fast to it, and are subsequently pumelled to death without landing a blow...

Making keen judgement between striking power (weaponry), striking ability (adjusted dexterity) and safety (armor) is at the heart of winning in MELEE. Half the battle can be won before you step on the field, especially if you know what your adversary will be armed with. Armor and shield protection are easy to compare with weapon power, proper weapon choice is somewhat harder, but deciding on an optimum adjusted DX is a more delicate task than it first appears.

The use of three dice in determining hits is unique enough so that most gamers will not have a "feel" for the probabilities as they do in most other games. When

allotting points to strength and dexterity in setting up a fighter, one naturally treats each point as equal, comparing values as simply the difference in points. A beginning player will treat the difference between 10 points and 9 points the same as 15 and 14, when the former is actually over twice as decisive.

The table below gives the probabilities for striking an opponent for different adjusted dexterity factors. Notice how the differences between values are largest in the middle, where sacrificing DX for armor or strength is most common.

This table gives a much better picture of point value than intuition can. A DX of 6 has twice the chances of the automatic 5, and 12 is eight times, not twice, greater than 6. This is not to say that you should try for the highest DX you can. It is still up to you to decide how to balance a fighter's abilities to meet your tactical demands. Making sacrifices is necessary, but one needs to weigh the amount of sacrifice in order to achieve brilliance as a warrior.

ADJ. DX	% CHANCE OF HIT	% INCREASE FROM LAST	% CHANCE (DODGING)	% INC.
5	4.6		0.2	
6	9.3	100	0.9	310
7	16.2	75	2.6	206
8	25.9	60	6.7	156
9	37.5	45	14.1	109
10	50.0	33	25.0	78
11	62.5	25	39.1	56
12	74.1	19	54.8	40
13	83.8	13	70.2	28
14	90.7	8	82.3	17
15	95.4	5	91.0	10

CHANCE OF DOING TRIPLE DAMAGE (any DX) 0.5%

CHANCE OF DOING DOUBLE DAMAGE (any DX) 1.4%

SCIENCE FICTION AND FANTASY GAMING: OUR OWN GENRE?

by

Tony Watson

When the amount of information in a given field expands, there is a natural tendency for the people involved in that field to specialize. The plethora of new ideas and information no longer allows an individual to handle the total field in an efficient manner. Thus, we have more and more chiropractors, pediatricians, and neurosurgeons and less general practitioners.

Could the same be said for wargaming in general, and SF&F gaming in particular?

Everyone is well aware of the rapid growth of the gaming hobby and the flood of titles in the last few years. Players can no longer purchase, let alone digest and fully appreciate, all the games now offered. Players are choosing their games more selectively, some choosing to remain loyal to a particular line of games, or those of a certain era or type.

It has long been true in the case of Diplomacy, that while a number of wargamers enjoy playing Diplomacy, far from all Diplomacy players are wargamers. While the populations of both playing groups have a sizable overlap, it is not axiomatic that all Diplomacy players are wargamers. I cite this example to show that it is indeed possible for a game, or type of game, to attract a following that does not come exclusively from the wargaming hobby.

In its infancy, SF&F gaming was judged a poor relation by the mainstream of the hobby. Spaceships were regarded as somehow less suitable for gaming purposes than panzer divisions. SF&F games were a decided

fringe element of the hobby. While there were some good efforts (Notably LENSMAN and some postal games) space gaming remained largely neglected.

But, the SF&F bug wouldn't go away. The hobby expanded its horizons and in 1973/74 SF&F came into its own. The publication of (now classics) STARFORCE, STELLAR CONQUEST, and TRIPLANETARY as well as the fantasy role playing DUNGEONS & DRAGONS catapulted SF&F into popular recognition. They were high quality, professionally done games (STARFORCE being an effort by the hobby's premier company, SPI). More importantly, they were good games.

Since then, this particular part of the hobby has blossomed, growing substantially each year. We now have more titles (also our fair share of turkeys) and more and more gamers are having at least limited experience with SF&F games.

But can we truthfully say we are a separate genre? I think so.

All the elements are present: communication, titles, and gamers interested primarily or exclusively in SF&F.

Apparently a number of companies recognize science fiction games as independent enough from mainstream wargaming to need their own journals. Thus we have Metagaming's The Space Gamer, TSR's The Dragon, and Flying Buffalo's Supernova; all exclusively SF&F 'zines. The fact that there are enough people to support such expertly done publications as TSG or The Dragon is indicative of the need and desire among gamers for 'zines of this nature. Through letter columns, reviews, press releases, and articles

contained therein, SF&F gamers discuss the games they play, and read articles concerning "good" play, design and added rules plus features.

SF&F gamers can now choose from a large selection of titles, with subject matter ranging from role playing games to miniature rules. The infusion of the big name companys, AH and SPI, has been important. These companys are known for quality and have brought their reputations into our field. We even have our "own" company in Metagaming, in that they produce SF&F exclusively. TSR is noted for fantasy products and other, smaller publishers have found the room to bring us their good ideas.

This brings us to people, the most important element of all. We already have the publishing and design personnel, but do we have the gamers? People who are primarily into SF&F, and not wargamers who play an occasional SF game? I think we're approaching the point where a sizable portion of SF&F players will consider themselves SF gamers, not wargamers. Already there are a number of people who'll play D&D eight

hours straight but you have to tie them to a chair for a SPI game. More and more players are venturing over from standard subject wargames and spending their time and money on SF&F.

Another fact that shouldn't be ignored, is the whole new source of players being tapped only recently. That's the people who have never played any kind of wargame. They are being reached by the full page ads in the digest size SF magazines such as Galaxy and Analog. Open up any recent issue; most likely you'll find a full page ad somewhere for STARWEB or OUTREACH. These new people, if they can adjust to the initially overwhelming world of SF&F gaming, are sure to make important contributions to the hobby; they'll be people whose main interest is SF, not wargaming.

The potential scope of SF&F gaming is nearly limitless. Can it grow enough to be considered as a genre in and of itself? I think we're moving that way now, and at a good clip.

And I think it will be nice when we arrive.

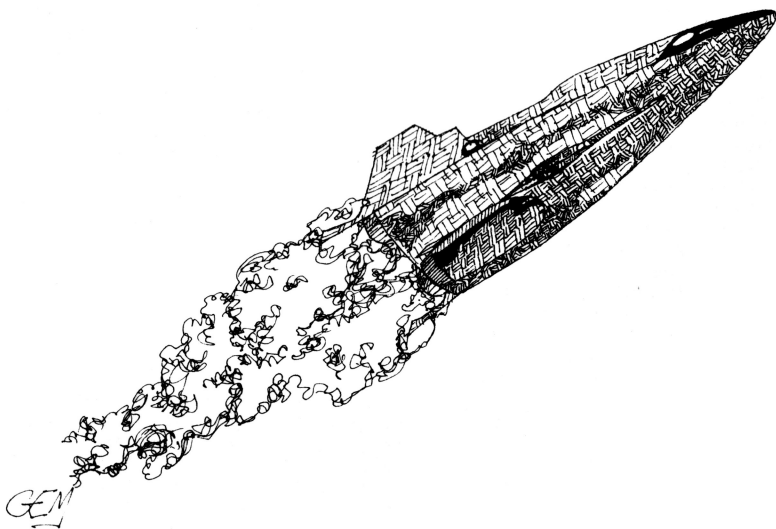

NEWS & PLUGS

New releases from The Chaosium; P.O. Box 6302; Albany, CA 94706 are ELRIC and TROY. ELRIC is based upon the creations of Michael Moorcock. The game includes a full color map of the Young Kingdoms, two sets of playing pieces, a deck of magic cards, eight sheets of individually drawn Battalia sheets, and an illustrated rulebook with scenarios for two or more players. TROY relives the epic battle of the ancient world. The game includes a map of Troad, an illustrated rulesbook, 252 counters all in a zip-locked bag.

The Strategists Club Nominating Committee recently sent out letters asking 42 persons to participate in an expanded committee. All 42 persons owned or worked for game companies or published gaming magazines. The list included three persons each from SPI, Avalon Hill, TSR Hobbies, and Game Designer's Workshop. Two persons each were from Battleline, Heritage, Mini-figs, Z&M, and Grenadier. The rest of the list was composed of individuals from other organizations including Howard Thompson from METAGAMING. The Committee's return address was that of TSR Hobbies in Lake Geneva.

Howard Thompson refused committee membership with "the hope that hobby awards will eventually be the province of the gamers."

The purpose of the expansion was "to make this event more meaningful." The awards have been heavily dominated by TSR products in recent years. The current fifteen members of the Committee are are Detroit-Metro gamers and they would have the option to stay on the Committee.

TSG staff research revealed that the Charles Roberts Awards given at the ORIGINS conventions have yet to nominate any TSR product. This contrasts sharply with the TSR dominated Strategist Club awards. THE SPACE GAMER will report further developments in gaming awards as they occur.

TRAVELLER is a new release from GDW. It is a three booklet role-playing game similar to the many fantasy games currently so popular. The game consists of three 48-page booklets to govern adventures and campaigns in the worlds of the future. The many facets of the rules make the game playable by groups, individuals, even solitaire. Playing time varies, but can run under an hour to over six hours depending on the adventure. For more information, write to 201 Broadway; Normal, IL 61761.

METAGAMING is interested in acquiring a limited number of shares in other gaming corporations. Those who own shares in other war-game corporations and are interested in selling their stock should contact Howard Thompson; Box 15346; Austin, TX 78761.

A settlement to Conan rights has finally been reached. Conan Properties Inc. has been established to control all rights. The press release stated "manufacturers of games, toys, t-shirts, and similar merchandise will be offered an opportunity to sub-license the use of the name 'Conan' through counsel for the corporation Arthur M. Lieberman, Esq.; 60 East 42nd St.; NY, NY 100017." (Item courtesy of Locus)

Spider Robinson has quit writing his review column for Galaxy Magazine. Reasons cited by Spider included late payments, up to 18 months, for previous columns, and "tampering" with his columns already accepted. More details on Spider's action, including the text of several letters, appear in the September, 1977 issue of Locus.

This would seem the place to again recommend science fiction fandom's excellent newspaper Locus. Twelve issues are \$6.00 from Locus Publication; Box 3938; San Francisco, CA 94119.

New releases from Der Kriegspielers Fantastiques range goobles and boogers fantasy figurines: bat-like thing set, stubborn krot set, tasmanian devil set, hunched-back grunch set, skeleton men set, pixies set, hairy-nude taino set, and amazons set. The Fantastiques are manufactured by Heritage Models, Inc.; 9840 Monroe Drive, Bldg. 106; Dallas, TX 75220.

This Quarter of the Universe is Ours!(A Handbook for Building Three-Dimensional Star Maps) is available from Theta Enterprises, Dept. TSG; 829-J Tejas; Richardson, TX 75081. Includes computer coordinate translations of the entire Gleise Near Star Catalogue. Stars within 6 par secs to unit parsec and in 3 in. /parsec scale. Six parsec exterior front view key, complete instructions and diagrams for building 3 foot 3D map of 80+ nearest stars within 6 parsecs. The working computer pgm. General advises on Star Map design. Easily understood and useable format allows you to apply the data to space games of your own design, whether hard copy or computer assisted.

From TSR, LEGIONS OF THE PETAL THRONE, a fantasy miniatures wargame rules booklet for the world of Tekumel. Intended for use with their 25 mm. figures for playing out large-scale battles from EMPIRE OF THE PETAL THRONE. For more details, write TSR Hobbies, Inc.; Box 756; Lake Geneva, WI 53147.

Jim Odom of Heritage Models in Dallas, Texas, and Steve Peek of Battleline Publications announced the merger of their two firms effective October 5, 1977. Joint offices will eventually be located in Dallas.

Steve Peek felt the move would enhance Battleline's board-game quality and marketability. "...I believe that the physical quality of our games will improve tremendously within the next twelve months. For instance, as we release new games and reprint old ones we will be mounting the boards," said Peek. Odom of Heritage commented, "we hope to expand the entire boardgame market."

Heritage thus continues expansion by acquisition. Custom Cast Models was a previous addition. Duke Seifried of Heritage has also informed THE SPACE GAMER that the game IMPERIALISM has been acquired from Flying Buffalo, Inc.

WINTER WAR V, the annual games convention of the Conflict Simulations Society at the University of Illinois, will be held January 20-22, 1978, in the Foreign Language Building. Tournaments will include DUNGEONS AND DRAGONS, DIPLOMACY, WWII armor, Napoleonic miniatures, a marathon TERRIBLE SWIFT SWORD game, and the new space/economic game HYPERSPACE EXPLORER; also, a TRAVELLER tournament sponsored by GDW and naval miniatures (by C in C). Other activities planned include computer games demonstrations, auctions, dealers, and a series of seminars on all aspects of historical simulations. Frank Chadwick, a game designer for GDW, will give a game design seminar. For more information on parking, lodging, etc. write to: Tony Svajlenka, 2020 N. Mattis #201M; Champaign, IL 61820; phone (217)359-6307.

TEXCON will be held March 24-26, 1978, at the Stephen F. Austin Hotel in Austin, Texas. This will be the largest, best organized and planned game con yet in the Southwest. METAGAMING will be in attendance in a major way, introducing the first gamemaster's package of THE FANTASY TRIP: IN THE LABYRINTH. Also, METAGAMING plans GODSFIRE gaming and open play of all MicroGames, as well as a STELLAR CONQUEST tournament. Other planned activities include a DUNGEONS AND DRAGONS tournament layout for miniatures play and AFTERMATH, which is a running multi-player scenario in a bombed out city, using SNIPER rules with a slavery post and supply columns. For information contact: TEXCON: Box 12385; Austin, TX 78711.

"The Return of ORCCON" will be held at California State University Fullerton, on January 13-15, 1978. Events will include board-games, D & D tournaments, miniatures, and a STELLAR CONQUEST tournament. Cost is \$2.00 to pre-register or \$3.00 at the door. For further information contact: James John Myers; 13718 Norbeck Drive; La Mirada, CA 90638.

Wargy 6 will be held January 7 and 8 at Platte Technical College in Columbus, Nebraska. Sleeping overnight in the student center is included in the \$5.00 entry fee. For further information, write: Rick Plankinton; Box 52, RR6; Columbus, NE 68601.

Metro Detroit Gamers will hold their eleventh major gaming convention, MDG WINTERCON VI GAMEFEST, on December 2, 3, and 4, 1977, at Oakland Center; Oakland University; Rochester, Michigan (north of Detroit). Special guests from SPI will be James F. Dunnigan, Howard Barasch, and Richard Berg. Features include tournaments, open gaming, food on premises, door prizes, seminars. There will be a wide variety of games: two-player, role-playing, multi-player wargames, adult, family, sports games and miniatures. For more information, send a self-addressed and stamped envelope to: Al Slisinger; 19941 Joan; Detroit, MI 48205.

ORIGINS 78, presented by the Metro Detroit Gamers, is going to be held at the University of Michigan, Ann Arbor, on July 14, 15, and 16, 1978. Among the planned activities are large miniatures participatory tournaments, expanded exhibits, an extra large D&D tournament, non-tournament events, and a new series of national awards for excellence in miniatures. For further information, send a self addressed and stamped envelope to Metro Detroit Gamers, c/o Al Slisinger; 19941 Joan; Detroit, MI 48205.

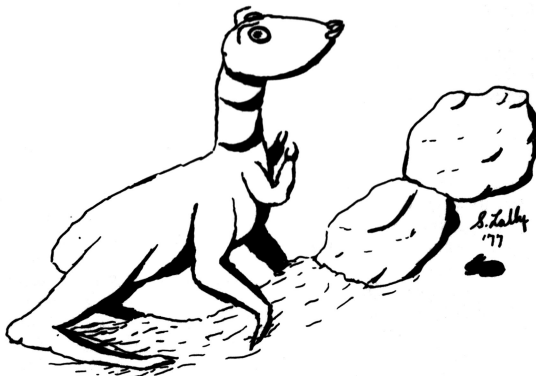

AGGIECON IX will be held at Texas A&M University, March 30-April 2, 1978. Guest of honor will be Phillip Jose Farmer and master of ceremonies will be Wilson Tucker. Films to be shown will include Westworld, The Rocky Horror Picture Show, War of the Worlds, 2001, Futureworld, and Wizards among others. Events of interest will include an amateur art contest, readings, speeches, panel discussions, a dealers' room, and clips of Star Trek bloopers. For more information write: AGGIECON IX; P.O. Box 5718; College Station, TX 77844.

WARCON IV will be held January 27-29, 1978, at Texas A&M University. The METAGAMING staff will attend for the third year. More information will be forthcoming on the oldest Texas wargame convention.

PhilCon77, the 41st Philadelphia science fiction conference, will be held November 11-13, 1977. Principal speaker will be Hal Clement. Events will include films, creative exhibits, auction, and a costumed event (with lasers and prizes). For more information, contact PSFS; c/o P. B. McGrath; 134 N. Green Street; Langhorne, PA 19047.

GENCON SOUTH, sponsored by The Cowford Dragoons and TSR, will take place February 10-12, 1978. The Jacksonville Hilton, the area's largest convention site, was selected for the activities because it offers ample exhibiting and gaming space. Assisting the Cowford Dragoons will be the International Plastic Modelers Society which will sponsor model contests. GENCON SOUTH will be the largest annual wargame convention held in the South and all manufacturers and exhibitors are urged to participate. For more information write Carl Smith, Cowford Dragoons; 5333 Santa Monica Blvd. N.; Jacksonville, FL 32206; or call (904)733-3796.

ChattaCon will be held in Chattanooga, TN on January 6-8, 1977. A. E. Van Vogt and Perry Chapdelaine will be guests. Activities include a huckster table, banquet, and art show. For more information, contact: Irvin Kock; c/o 835 Chattanooga Bank Building; Chattanooga, TN 37402.

For fans of science fiction, fantasy comics, nostalgia, and just plain fun, MYSTERY CON will be held November 25, 26, and 27, 1977 at the Downtown Holiday Inn; 801 Calhoun Street; Houston, Texas. Appearing in person will be Darth Vader. In addition, there will be over one hundred hours of films (King Kong, Marooned, Forbidden Planet, among many), a dealers room, an auction, door prizes, an art room, shows from t.v. (Twilight Zone, Star Trek, Superman), and Allan Asherman will be on hand to show his nationally known Star Trek special effects slide show. There will also be a costume contest. For more information, contact MYSTERY CON II at 4045 Linkwood Street, Apt. 518; Houston, Texas 77025.

In response to many requests for aid in contacting local gamers, THE SPACE GAMER will give brief mention to clubs that do some science fiction and fantasy gaming. Send the name of the club, address, and other pertinent information to METAGAMING; Box 15346; Austin, TX 78761.

The MIT Strategic Games Society (MITSGS) meets all day Saturday and Sunday at the Walker Memorial Building; Memorial Drive; Cambridge, MA. Games played include SPI, Avalon Hill, D&D, Traveller, miniatures. The MITSGS is co-sponsor (along with the American Wargaming Association) of the semi-annual conventions: WINTERCON and SUMMERCON.

LUCIFER'S HAMMER by Larry Niven and Jerry Pournelle, Playboy Press, \$10

THE DOSADI EXPERIMENT by Frank Herbert Berkley/Putnam, \$8.95

THE COMPREHENSIVE GUIDE TO BOARD WARGAMING by Nicholas Palmer, Hippocrene, \$12.50

Larry Niven and Jerry Pournelle are great individual writers. But, they get together every now and then to collaborate on a book which would technically qualify as a 'classic'. THE MOTE IN GOD'S EYE was a classic of the FIRST CONTACT variety. All the elements of a good SF novel were present in MOTE. It was comfortably long, the characters were full blown, the aliens were strange and had different ideas about everything. THE MOTE IN GOD'S EYE was complete, almost too complete. I had the uncomfortable feeling that I was reading a novel that had been planned and planned and planned to death. This didn't take away from imaginative thrust and power of MOTE, but it was a nagging feeling that hung around it whenever I picked it up.

Niven and Pournelle have dipped into the chest of collaboration again. This time it is with a book called LUCIFER'S HAMMER. With this latest effort, the powerful duo give us a classic of the POST-CATASTROPHE type. The plot deals with the discovery and subsequent collision with the earth of the Hammer-Brown comet. Yes, 'Hammer', the press slurs the name of the discoverer of the comet and re-dubs it "Hammer". The name sticks, and the comet fulfills its new name's purpose. The central plot tells of the survival efforts of various groups of survivors. The tragic aspects of the death of the majority of of the world's population are soon forgotten, as the 'good guys' attempt to defend their stronghold against cannibals (the food supply dwindles rapidly since the weather goes out of control). The characterization of most persona is adequate, but this book is really aimed at a 'mainstream' audience. The comet does not land until half way through the 494 pages. The pacing is much better after the action starts, but I was very aware of the people that would be reading this when the comet was explained for the third time. Only a non-SF reader would need this excess of information. This should not be held

against Niven or Pournelle. They want and deserve the spotlight. I wish them the best of luck. I don't think this book will do it for them however. There is still an abundance of SF ideas present, and those just aren't going to appeal to the best-seller-only bunch.

There is a story going around about LUCIFER'S HAMMER. The story says that Niven and Pournelle had written a novel about an alien invasion, and the editor of their book publishing company said "Too long!". They returned later with only the first half of the novel, the landing, via comet! A change here, and tweak there, and we get the latest from a couple of very prolific pens.

I recommend this book, but if you are tight on money wait for a paperback. Don't miss it for a long, interesting story. I feel that the second part will be much better, and I hope we can read it very, very soon.

The best book to have crossed my desk in a long time is a superb adventure novel by Frank Herbert. THE DOSADI EXPERIMENT is possibly the best book Frank Herbert has ever written. Yes, I know he wrote DUNE. I think this book is better. DUNE, although considered by many to be the best science fiction novel ever, is a massive exploration of a writer's imagination. It is good, very good. But it only explores the limited rage of a few basic types of humans. Here is where THE DOSADI EXPERIMENT differs. It deals with aliens, and I do mean aliens. The Gowachin, Wreaves, and Calebans are the most excellent of all SF creations, believable aliens. So many books claim to have natives of Rigel III, but few deliver. This couldn't be further from the truth with Herbert's new book.

The story deals with Jorj X. McVie, hero of Herbert's earlier novel, WHIPPING STAR. It is not a sequel, although it would be very helpful to have read it before reading DOSADI. McVie works for an organization called The Bureau of Sabotage or BuSab. He is charged with the duty of discovering where Dosadi (a planet) is, what is going on there, and who is doing what. You can see there is very little known when the book begins, but soon the information flows freely. The problem with this information is the seemingly pointless direction all leads take. More information means more questions. More than any other book of Herbert's, this reminds me of his excellent THE DRAGON IN THE SEA (or UNDER PRESSURE, or 21st CENTURY SUB). The wheels-within-wheels plotting is one of the most enjoyable reading experiences

any SF fan can nave. I recommend this book highly. I see a Hugo in the future of Mr. Herbert.

Nicholas Palmer's book, THE COMPREHENSIVE GUIDE TO BOARD WARGAMING is a welcome addition to any SF&F gamer's library. This is a first of sorts, a book about the hobby of wargaming for non-gamers and gamers alike. Sections of the book include Preliminaries (a more or less history of wargames from Reisswitz's sand table to present and some basics), Strategy (3 chapters on planning, reserves, build-up, politics, and economics), Tactics (3 more chapters on terrain, combined arms, and water/sky games), Winning (2 chapters about gaining tactical advantage and the 'ideal gamer'), a sample game (THE BATTLE OF NORDLINGEN), and the most interesting section, Simulating History on \$10 a Day.

This latter section is a rundown of current games which covers 62 pages. SF&F games included are STELLAR CONQUEST, STARFORCE, STARSHIP TROOPERS, STAR RAIDER, STAR SOLDIER, WHITE BEAR AND RED MOON, TRIPLANETARY, and THE YTHRI. Each entry includes a summary of the game and a rating. Other games listed are just about every game in print.

The nicest thing about this book is that a publisher somewhere feels wargaming is a good enough investment for a superior 'production' book. It will become a standard reference work for board wargaming. After all, the first is always in the position to become THE book of any field.

There is very little new here for the experienced gamer. The content of SF&F games is almost invisible. Volume II, which is said to be in production, will have to contain much more about the 'fantastic' side of gaming to truly satisfy me.

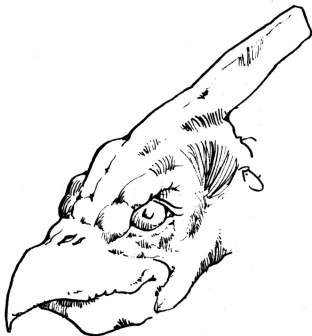

(WHERE WE'RE GOING from page 1)

less busy work for game masters. No, we really don't expect TFT to replace D&D, but it should stand equal to it in terms of numbers of games sold and convention tournament events. That will probably take 3-5 years. Some METAGAMING staff member at the SF Worldcon reported that a "D&D Magic User" got one of the biggest hands in the costume event. Popularity like that is hard to beat.

Current MicroGames in the works to follow WIZARD are about four in number. OLYMPUS MONS, the U.N. Mars Raid by Lynn Willis may be Micro #7. GEV, the second game in the OGRE series may make #8 or #9 (Steve has to get TFT out first) SKYWARS, a nifty air attack game "inspired" by STAR WARS may also make the #8 or #9 slot, or WARPDUEL, an individual ship combat game, related to WARPWAR may make one of those slots. Steve also has some solitaire, programmed LABYRINTH adventures in the works that will come out in 1978. There is a future man-to-man combat game kicking around that may be tied to TFT in terms of character creations and some other basics. Most fantasy gamers don't want blasters in their castles, but those who do may find the conversion very easy in TFT system.

METAGAMING will be at ORIGINS '78, TEXCON in Austin, WARCON at Texas A&M, and the World Science Fiction Convention in Phoenix. Our convention schedule will always be sparse because we prefer to stay home and "mind the store."

Next issue will see the first of what will become our annual feedback forms. This will be a huge form covering just about everything. We ask you to be sure and send it back to us because game ratings, our future plans, etc. will depend a lot on what you say. We are going to ask the questions only once per year, so you can be assured we will listen to each and every comment.

I can't find enough good words for those of you who have told stores about our games. More than half of all stores we service we picked up because some reader got them interested in us. Science fiction stores and game stores want to carry goods their customers like; so they listen to your requests.

ABSOLUTE ZERO

BY ELLADAN ELROXIR AND G. ARTHUR RAHMAN

ACROSS THE VOIDS OF NEARLY ABSOLUTE ZERO COMES THE MIGHTY **WARFLEET OF PLUTO!** PLUTO IS A HARSH, IMPOVERISHED WORLD, EXPLOITED TO RUIN! THE PLANET SUPPORTS A SMALL, DEMORALIZED POPULATION, PREYED UPON BY A PARASITIC BUREAUCRACY! ITS **MILITARY** HAS SEIZED UPON THIS FACT AS AN **EXCUSE** TO EMIGRATE TO GREENER PASTURES! THE **INVASION** IS ON!

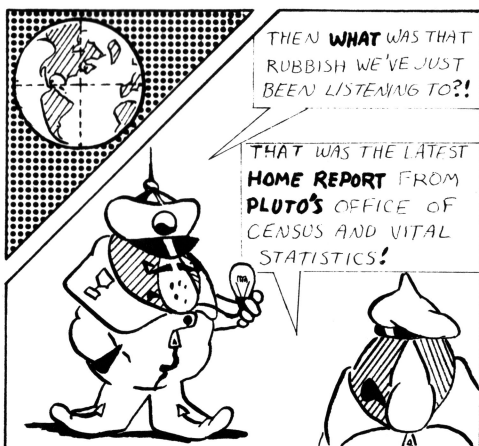
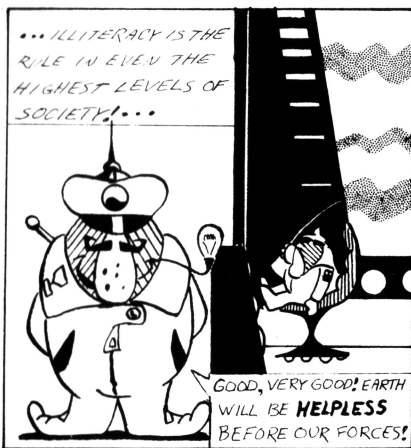
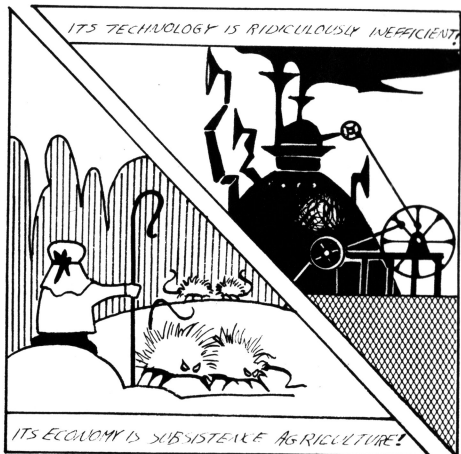
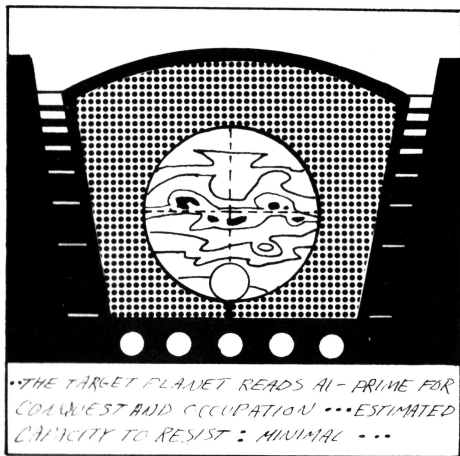

DESIGNER'S NOTEBOOK

Well, WarpWar is out; those of you who advance-ordered should already have it. It turned out pretty well. Howard has a long article about it, in this issue.

Next off the blocks will be Robert Taylor's RIVETS, MicroGame 5. As I write this, we're playtesting a "final" draft... it's a touch wordy yet, but plays well otherwise. The art has to be seen to be believed. RIVETS should be ready for shipping about October 15.

As for my own work, WIZARD is coming along fairly well. As of now, it looks as though one of the key features of the game is going to be detection of phantom units...you opponent is creating a number of beings and throwing them at you...but which ones are "real," and which ones are only shadows? Of course, the more energy he spends on creating harmless phantoms, the less he has left to put into the dangerous stuff...

There'll also be a large variety of more conventional magic spells, including several intended for use on enemy fighters, so you'll be able to combine WIZARD and MELEE.

As far as physical quality of the game goes, it'll be a step up from the earlier Micros...a longer rulebook with a color cover and bigger map. Map and counters will be in the same style used for MELEE...big hexes, and giant-sized illustrated counters. This will set the game's price at \$3.95 (TSG/\$3.50).

Also still coming along is GEV. As this is written, comments on the proposed ORGE revisions and new Ogre-universe game (TSG 12) are beginning to come in...but won't hurt. So far, a majority of people seem to favor most of the proposed changes...with the exception of the revised ramming rule. We're rethinking that one. GEV might be MicroGame 7...but it's more likely to be 9 or 10.

The first FANTASY TRIP solitaire game (new working title: DEATH TEST) is being playtested both by the Metagaming crew and by a gang of talented maniacs in Bjornsborg (excuse me...San Antonio.) It already works...by the time we're ready to release it, it'll work better. If you're INTERESTED in solitaire/programmed games, let us know...that's something we need to make a decision about.

Ben Ostrander, Robert Taylor, and I made it to the 35th World Science Fiction Convention, alias SunCon, in Miami a few weeks ago. Got to talk (at least a little

bit) to Heinlein, Zelazny, Niven, Pournelle... (if any of those names mean nothing to you, check the bookstore.)

Also got to talk at length to Mike Kurtick, who designs games for Lou Zocchi. He worked on SPACE PARTROL (see next issue for review), did the original STAR-GUARD, etc. Very nice guy. Mike has some interesting projects in the works. I won't spill them because I'm not sure how much of our conversation was under the rose...so keep reading TSG. Plug, plug. One thing we did discuss was Star Wars. Nobody has yet been licensed to produce a Star Wars wargame. Apparently, somebody up there doesn't know the difference between Monopoly and Blitzkrieg. Somebody should tell them there are DIFFERENT KINDS of games..Ah, well. I imagine half the people who are reading this have already worked out their own Star Wars simulation, and the others are only waiting for a little hard data. So it goes.

Speaking of game designers, I also ran into Greg Costikyan (SPI - Battlefleet Mars, the upcoming Swords & Sorcery, etc.) at a party the night the con ended. Didn't get to talk much, though, as we had both been having a little bit to drink and everyone was singing "A Clone of My Own". He told me something about S & S, but I can't remember what it was. (I can't even remember where that party was.)

The other thing I saw at the con was COSMIC ENCOUNTER, the new quasi-wargame that's been getting such wide advertising play. I tried it a couple of times. Mixed reactions. It's incredibly easy to play, and entertaining...you get a lot of interaction. The "hard" science-fiction content is nil, and what passes for "science" is totally laughable. There's room for strategy, but it is NOT battle-field strategy...more like poker. (You actually play with cards and chits, on a map with five (count 'em, five) hexes. The game is lavishly produced...a really beautiful job. This might be a game to buy if your friends hate all your other games...it's not as good as the ad hype makes it out to be, but it's probably worth \$10.00 to a lot of people. They have two "expansion sets" coming...these apparently give you new components, but no new rules.

FOOL'S CHOICE

a short work based on STELLAR CONQUEST

by

Ted Butler

He was right he thought as he hurriedly walked. But the fool wouldn't listen.

He forced himself to walk slower as he passed the guarded gate. If Haansen had put out a general pickup order...

There! On the street just past the gate stood the early warning center. For months now it had tracked the converging drives of two ships coming across the cluster. Colonel Hardryn Mart, of the relatively new intelligence corps, had bitterly watched this confirmation of his work. Finally, he went again to the Planetary Commander, Haansen, for a last appeal.

Again, his appeal had fallen on deaf ears, but this time there was a difference. Piling nonsense on stupidity, he had been relieved of duty, confined to quarters and arrested.

The commander had been sarcastic. "You, Colonel Mart, my dear chief of Intelligence, recommend I abandon six missile bases, and flee with three battle ready escort class warships from two unknown ships on a reconnaissance?" Haansen had built up the defenses of this planet from nothing to the present high state. Now he finished on a note of rank unbelief. "Why, I'd put this defense up against the best the Empire can space."

"Sir, to begin with, you are assuming they are scouting," Mart replied.

"And what else could they be doing this far from the Taad part of the cluster?" Haansen asked condescendingly.

"Sir, I've told you of the missing colony ships of the Taad's," Colonel Mart responded wearily.

"Those 'supposedly' missing ships," Haansen interrupted, "and about the 'secret' colony they might have founded. The same one they've never sent a ship to since our own colony was founded twenty years ago. The old records aren't that reliable. Your speculation is just too fantastic."

"But that colony might exist, sir."

Mart protested, "The records do show several likely systems were visited by a large task force and they are the type we check for prime industrial worlds."

"And why would it have remained hidden?" The Planetary Commander demanded. "The Taads have been actively at war with the Daviid people for over twenty years. Our drive detectors suggest some very costly battles for both sides and at least one lost system for the Taads. Why would they keep a high resource colony useless when they are sorely pressed?"

"I don't think they lost any colonies, sir," Mart protested. "And if you look at the data, more Daviid drive traces disappeared than Taads. I think the Taads duped the Daviids into attacking an empty system by defending it massively. I think the Daviids paid a very high price for their attempt at enslavement with no return. And I feel they established a secret resource colony with us in mind. You and I both know our intentions are hardly friendly toward them. We've been vigorously trying to scout them for years. They've been just as vigorously hunting down our scouts and destroying them before we could learn anything. And, I'd like to point out sir, their drive detectors point to our colonies just as ours do theirs."

"Honestly Colonel," Haansen said impatiently, "now you have these 'supermen' anticipating a war with us by thirty years!"

"Why not? If they could be clever with the Daviids, they could trap us into feeling secure. I think their record shows how they act."

"More illusions. I say the Taads lost a border colony, and that you are seeing Taads in the woodwork." Haansen said. "Enough of this, our defense is being delayed. Our warships must be ordered to their stations." The commander rose in dismissal, his patience at an end.

"Sir," desperately Mart remained seated, "let me finish. One of the drives originated from the system I picked most likely for the hidden colony. Except for

this drive nothing has left or gone to that star system for three decades!"

Haansen sat back down, blinked momentarily, then nodded. "So Detection must have plotted a wrong course. That organization needs a house cleaning."

Hardryn Mart, feeling like he was drowning in a nightmare, tried again, "Sir, I'm certain even your defenses can't handle what's coming. If that colony laid undisturbed for thirty years on a prime industrial planet, they could have developed things our research is only now projecting. They might have build those things. They..."

The slur on Haansen's proud planetary defense was too much. "SILENCE!" he screamed, as he lunged out of his chair. Mart, startled, slumped back into his own seat.

The Planetary Commander sank slowly back into his chair, paused for control, then went on, "If, if, if; I believe; maybe; could have. All wild supposition. An intelligence officer should work with facts. Mart, you've done excellent work in the past, but you have become so obsessed with those 'giants' across the cluster, that you are useless to me and your Empire. You will confine yourself to quarters. You are relieved of all duties and will consider yourself under arrest. I'll convene a court martial, or perhaps a competency hearing, after we've dealt with this patrol." Haansen leaned slowly back, daring the other to speak with his eyes. Then he spat out, "Now, get out."

The ex-planetary intelligence officer left slowly.

Hardryn Mart seethed as he forced himself to casually return the salute of the Intelligence Building door guard. He had now disobeyed his superiors direct orders. He KNEW Haansen courted total disaster. Oh, on the surface the Planetary Commander was reasonable. Except for the unsuccessful scouting of the Taad part of the cluster, the Ward Empire had done very well in ship actions since it entered the cluster. For safety's sake, perhaps too well. Colonel Mart had run simulations from the Taad viewpoint and facts were fitting too neatly. The Taads weren't stupid. They wouldn't send two ships all the way across the cluster to scout what must be a known Empire center of power. Therefore they hadn't.

At least Colonel Mart could try to save his own staff. If he was wrong he would forfeit his career and likely much more if Haansen had his way. But he KNEW he wasn't wrong.

Later, he watched as the other two warships, including the flagship with Haansen aboard, took their final positions. Ironically, he was feeling guilty. Captain Pyter of this ship was an old friend, and Hardryn Mart had lied outrageously to him to get the entire intelligence staff aboard.

His attention was diverted from his thoughts by the sudden flurry of activity in the control room. One of the two drive traces had stopped a full klick outside the system.

Captain Pyter turned in puzzlement to his friend.

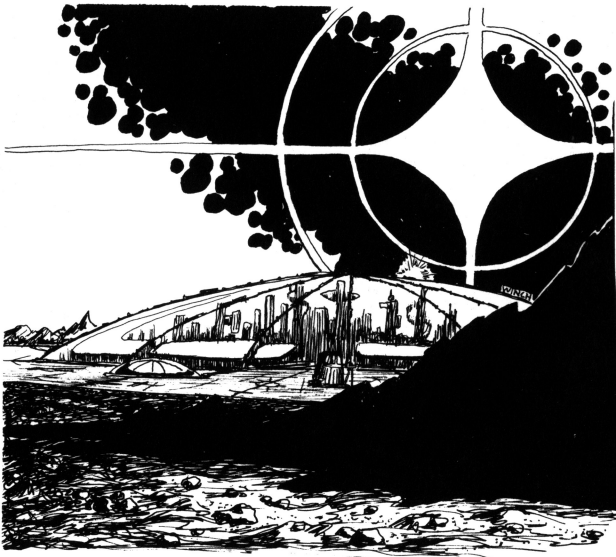

Hardryn Mart frowned, then realized what it meant. "I'd say he stopped because our fire could damage him if he joined the battle."

Pyter frowned too, then said, "But Hardryn, that implies the other ship..." Then he had to break off as the other ship jumped within range of the more informative short range detectors.

For a second no one in the control room seemed to breathe, then, pandemonium. She loomed huge in the screen. Mart suddenly recalled the research reports for the super ship to be developed after the attack class. They'd decided to call the class Dreadnought. The Ward Empire had projected it two research goals from now. Someone else had built it, and here it was. If it performed as the reports had suggested...

Captain Pyter moved rapidly to a console, scanned it, and then looked helplessly at his weapons console. In a second he was back by Hardryn Mart. "You knew this was coming", he said accusingly. "Never mind now. What the hell am I supposed to do? My instruments tell me our weapons won't even dent the hull on that thing and they're the best we have, the equal of the planetary defenses." His confusion was evident. A proud

fighting ship captain asking a desk type for advice?

Mart sighed, then "You must try to convince Haansen to save these ships and get a warning to the rest of the Empire. The colony will be conquered with or without destruction of your ship, captain."

Pyter started to protest, then looked as if he wanted to be sick. Still, he turned and ordered breakaway preparation for his ship, and sent a message to the flagship. Immediately came the order to commence firing. On the screen, the flagship opened up with its pitiful fire.

Mart looked at the useless weapons console. Then he looked back to the tactical display. The big ship floated completely unaffected by an apparent direct hit. Haansen was so damned stubborn. Even with immediate orders, seconds would be required to execute an escape.

The dreadnought, seemingly taking its time, finally fired. Suddenly the flagship flared brightly and was gone. The bridge crew was stunned with helpless horror and, a tinge of relief. Now, the big ship would have to take time for recharging its projectors. Time the defenders might use for escape. Then, the dreadnought's weapons fired again! Too quickly. Mart's jaw dropped as the deck

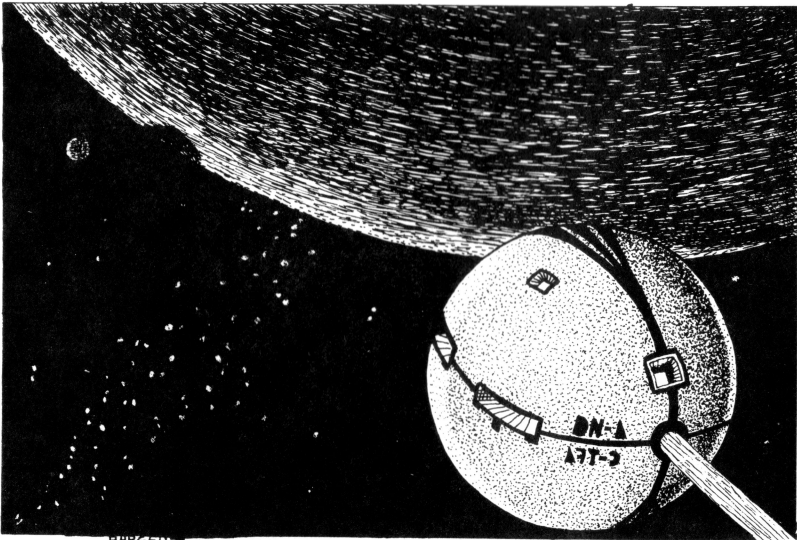

BARGER 71

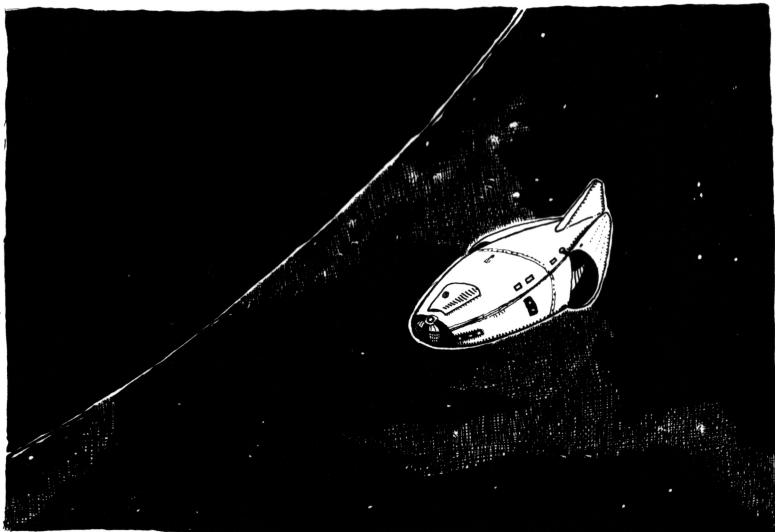

quivered from the near miss.

Hardryn gulped. The weapons gap was worse than he had feared. The Taad's ship had twice the fire rate of the Empire ships.

At last, with the flagship gone, Pyter was senior captain. His decision came quickly. The breakaway order was given. Then, after seconds that seemed a helpless eternity, both the surviving defenders escaped the doomed system. The ships turned and drove for the nearest of the older colonies.

Later, Captain Pyter joined Hardryn Mart in the tiny wardroom. He looked hard at the intelligence man. "I have to know. Can that thing be stopped, or will it gobble up everything we have?" The captain looked like a man whose foundation has just crumbled.

Hardryn took a drink before replying.

"I think it can be stopped, but only just, and only with the warning we bear. The two parent colonies have just developed new, advanced weapons. According to the reports and the information you gathered, those weapons should be able to fire at that monster with light effect. If we can use those weapons to hold it off, then the other new development, the attack class of warship, can be launched. Several of them will be necessary before the space around our systems will be ours again. They might be able to defeat that dreadnought, at high cost."

"Then, we can fight them." Pyter said. Hardryn Mart looked grim. "It will be costly. But, I think with care we can survive. Oh, in the end, we may be driven out of this cluster entirely. But the Taads will damn sure know they've been in a fight!"

CHITIN: I

a review

by

David James Ritchie

One look at the cover art, and you know you're going to like this game. The scene in green, blue and gold, of a savage insect warrior slitting the throat of another, sets the mood for the entire game. For those who like their carnage in cardboard, CHITIN:I is definitely an attractive brew. Metagaming's second MicroGame makes a good bid to be even more successful than the first.

Like MicroGame #1, OGRE, this game comes sealed in a 4½ x 7 plastic bag, but the packaging is deceptive. Inside is a heavy paper mapboard which folds out nicely into a 9 x 14 playing surface depicting a small river valley over which is layed the obligatory hexagonal grid. Also included is a half die-cut sheet of 112 counters portraying the two opposing armies in brown and white. Between the unit counters are 16 "chits" labelled from "A" to "F" which are the true *raison d'être* of the "harvest wars". The rule book runs to 17 pages, is clear and concise, and contains more fine artwork. The rule book art appears yet again in miniature form on the counters as a means of unit identification.

In concept, CHITIN:I is a relatively simple game. The underlying premise is that, given a species of intelligent insects inhabiting a world in which food resources are inadequate for all, wars will be fought over what food is available. Given that this hypothetical insect society has developed only to the foraging and gathering stage of economics, the nature of these wars will be limited primarily to encounters between competing foraging parties. Thus, we have the harvest wars. Within the small valley portrayed on the map grows a quantity of Vlaros, a food substance highly prized by all intelligent insects. From opposite corners of the valley, two foraging parties from separate hives approach. Somewhere in the center of the valley the two groups are bound to meet... at which point the game may proceed as a short,

sharp engagement or as a day-long pitched battle, depending upon the scenario.

Simple enough so far... but the actual tactical mechanics of the game are hardly simple. In fact, the game is as complicated as many a larger game and in that respect its size is a blessing. Complicated mechanics are not desirable when a large number of unit counters are employed in a game for the simple reason that they tend to become tedious. However, given the relatively small number of units available in CHITIN:I, such complexity as is present makes for an ideal game. The size allows players to concentrate on maneuver and the perfection of tactics. Yet, the game is not so simple-minded that it can become 'played out' after a few sessions. In this respect, Metagaming's advertising is extremely accurate. As a former sceptic, I must admit that I really did not expect to get "more play and more value" out of a "\$2.95 QUICKIE" than out of a larger simulation. I was wrong, CHITIN:I will take a long time exhausting its play value.

Specifically, the game differentiates between a number of unit types: Warriors, Leaders (called BASICS in the game) and Workers. Warriors are further divided into 5 classes: PLUNGE UNITS (flying insects), GANTUAS (Smasher Class), PHELANXS (Thruster Class), LOW RENDERS (Render Class) and TERMAGANTS (Hacker Class). Warrior class units provide the muscle in the game. Their purpose is to protect the Workers who cannot attack anyone (they can defend) and whose main purpose is to gather vlaros and get it off the board and back to the hive. The efforts of the warriors are directed by the Basics and both movement and combat are severely hampered by the absence of Basics. Pleasantly enough, however, the game's mechanics are not hamstrung by leadership rules, but rather enhanced.

Among the Warrior Classes, there is a rocks-breaks-scissors interaction which gives each Warrior type a definite role

to play in the game and encourages the formation of, in recognizable terms, a "combined arms" form of tactical deployment. For example, Smashers are considered to be used to best effect against Hackers and are, therefore, gifted with the addition of 1 combat strength point when attacking that unit type. Only Plunge Units do not fit into this tactical daisy chain-but they are immune to attack from any units except other Plunge Units. In addition to this method of differentiating between classes, the game allows for charge bonuses for Gantua and Phelanx units and for additional combat bonuses if a unit is attacked from any of its three rear hexes. Melee can become quite bloody when one starts adding up these bonuses to achieve high odds attacks.

Like OGRE, this game has both a relatively simple and short (45 minutes) basic game and much longer advanced version. One of the really brilliant design elements in the advanced version is a provision for the disposal of destroyed units: One point of food value is added to the nearest vlaros chit. The assumption is, of course, that our intelligent insect society is cannibalistically inclined and not terribly finicky since they eat both friend and foe indiscriminately. The bloodier the battle, the more food may be gathered to grace the tables of the Insecta gourmands back at the hive. Of course, since two victory are subtracted from each player's total for each friendly unit lost, players must be very careful to balance their losses against possible gains. The addition of this rule in combination with a rule ending the game when-

ever one player has lost or withdrawn all of his units, gives an almost strategic flavor to the game. One can envision players competing against each other in series of games (a 'la WOODEN SHIPS AND IRON MEN) in which it could be to one player's advantage to withdraw from the board and accept a loss in order to save some remnant of his army and lessen the impact of the loss of one game on the entire series. Players who wish to play out such a series will have to design their own system for it since the other wise thorough rulebook does not provide for series play among the 6 scenarios offered.

With the exception of series play, the game scenarios are remarkably complete. They progress in complexity from a Learning Scenario employing 18 units per side and a limited number of harvest chits to the "Armageddon" scenario in which all units and advanced rules are employed. No matter how little time you have or what your favored level of complexity, CHITIN:I has a scenario for you.

One of the game's few weaknesses is in the composition of the harvest chits. The chits are $\frac{1}{4}$ normal size and, like the rest of the game counters printed on an extremely lightweight cardstock. Those with fat fingers (myself included) may wish to cut out these chits and mount them on AH or SPI blank counters as this makes them far easier to handle.

Finally, since the title of the game is CHITIN: I, it is hoped that CHITIN: II is in the offing in the near future... perhaps dealing with a raid by one hive upon the underground vlaros storage areas of another hive. Given the fine job already accomplished on CHITIN: I, it would be a shame not to capitalize on an extremely creative system.

CHITIN: I is designed by Howard Thompson with illustrations by Paul Jaquays and is available from Metagaming at \$2.95 per copy/\$2.50 per copy to subscribers of the SPACE GAMER.

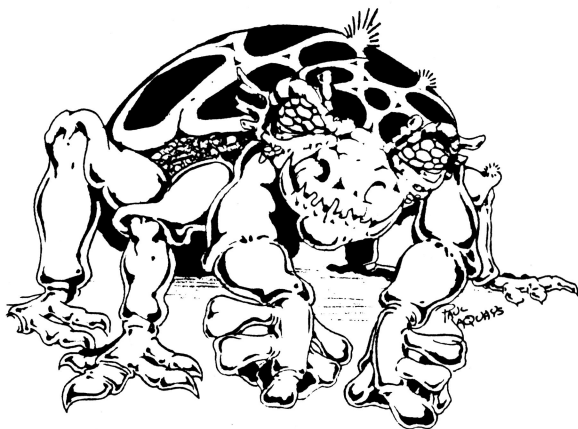

BATTLEFLEET MARS

a review

by

LYNN DAVID WOLPERT

The review of BATTLEFLEET MARS by Howard Thompson in *The Space Gamer* #12 pained me a bit, for it gave what I felt was a distorted view of the game. This is not to say that Mr. Thompson's review was without its good points. On the contrary, it had some fine comments on both Simulation Publications as a company, and on the game itself...Yet this second review still managed to be spawned. First, it is important for you, the reader, to know two things: I am by NO means an SPI fan. Second, my experience with space related games is somewhat limited, but feel this does no disqualify me to comment.

First, the rules. Yes, there was a lot of reading, but I found it enjoyable. The beginning includes three "official" reports that set the stage for the simulation. I found these to be some 'meat on the bones'. As for the rules themselves, though they were long, I felt they were a few steps above "poorly organized" (Mr. Thompson's quote). The rules were not what I call complete, but the problems I did encounter were all solvable by what we all lovingly refer to as common sense. A little bit of thought ended all difficulties.

Two comments that do need to be cleared up are those of the 'Time/Distance Measure' card and orbital tracks on the Solar Display Map. Mr. Thompson gives the impression that the measuring cards are a less-than-desirable element of the game. In practice though, they are rarely used. They are set up so that one can almost (and I do stress almost) tell without using the cards how long a trip will be from one planet or asteroid to another.

As for the orbital tracks themselves, Mr. Thompson mentioned that there was "a glaring example of incomplete development". He is wrong. It is possible to have more than a three month trip. Because the movement isn't possible by the Time/Distance card, doesn't mean it isn't both conceivable and useful. This is an example of what we are ALL guilty of at one time or another: cursory rule reading. The fourth track is used in conjunction with long trips that have involved a change of direction during flight. In fact, the flight rules seem

mathematically correct. Mr. Thompson was alert to point out the mixed concepts of precision and approximation. This last point was not disturbing enough for me to lay aside the game. After all, it isn't the first abstracted or fudged-for-game-purposes approach I've ever come across. All games have this problem to deal with.

Connected with this idea is the recording of points of arrival and departure for each fleet. This is simple enough. A piece of paper and any type of personal abbreviation solves the problem. In fact, Fleets move around enough that a spot on the record sheet for this recording would soon be hopelessly smudged. This is not to say there is a lot of bookkeeping, because there isn't.

The only addition I can make to Mr. Thompson's comment on the components, is that there are not enough! In the strategic game (because losses can be distributed so evenly during a battle), there tends to be little loss of individual ships. Usually one of the forces will retreat before any of the ships turn into flaming wreckage. So more ship counters, especially Catapults, would be useful. If the tactical part of the game is used in conjunction with the strategic (actually there are three games in one), the previous problem is not as serious. If it is mid-game or later, there seems to be a shortage of missile and fighter counters.

There is some truth to Mr. Thompson's comments on the political interaction part of the game. But, not the full truth. Yes, there is the rolling of a die in this phase, but there are decisions to make also. Especially for the Martian player. Decisions such as whether to try to use your political pull to drive the Earth morale down, or try to get the World Organization for Resource Development (WORD) to declare neutrality in the revolt. This in turn delays the Ares production schedule and raises the Martian morale.

The game can be won by the Martian doing nothing. BUT, if the Ares player is competent (this takes practice), and acts quickly in his attacks and production, it's a whole different game. The Ares player

is certainly the underdog or so it seems! This is part of the interest. Does a game always have to be so evenly balanced? I think not. Ares (through good play) can force the Martian to stretch his resources dangerously thin. With his superior production facilities every month (one game turn), Ares can produce many ships. Mars has no such luxury, and must work with what is available for at least eight months. Playing Ares is a challenge, just to survive. Playing Mars can be nerve-racking because it always seems you find yourself muttering, "If I just had a few more ships!"

This brings us to the real charm of the game. The factor that makes every move exciting. I was quite surprised it wasn't mentioned. A simple, quick system of Hidden Movement. Not hidden in the sense that you are unaware of the location of each fleet, but unaware of whether the fleet contains one ship or twenty! Each fleet is represented by a task force marker. Until fleets are in contact in orbit around a planet/asteroid, the size of each force is kept secret. So it is, that the tactics are not arriving when and where you aren't expected (this is impossible), but arriving with a fleet of the correct composition at the right time. It is all a game of bluffs. Is that task force just a scout, to discover my protective strength or is that task force a massive fleet on a raiding mission intent on capturing some of my territory

The uncertainty is what makes the game exciting. There are too few games around in which the lack of knowledge is an integral part of the game system. One of my most exciting and fearful incidents as a Martian occurred when I decided just sitting around and guarding my territory wouldn't work. Ares was building fast, and I was low on ships. I couldn't afford a half-hearted attack just to have it repulsed. I could not protect everything (even moderately well), if I made any attacks. The chance had to be taken. I completely stripped Mars and Jupiter (the two most important hunks of rock to the Martian) of their protective fleets. Only one ship was left left on each, and a lowly miner at that! If I was to carry out my attack, I had to leave them as such for at least four months. If only no Ares scouting ships discovered the weakness in time to launch a counter attack, I could win. The whole plan gave me the jitters. But, it worked- the two fleets devastated their objectives! The next month Ares had no choice but to capitulate to Martian demands; the Revolt was over.

We've heard the bad points of the game, but what of the good? I already mentioned its excitement value. More so, it is smooth. There is very little dead time between moves. If just the strategic game is played it is short. And a game that can be played in one sitting, is fun

and interesting, is nothing to scoff at. Campaigns are great, but every now and then it is good to sit down and play a game from start to finish. The fact that each side must play a different type of game adds to the interest. Above and beyond that, there are enough options open to each player so that every game is different.

The most enjoyable game to me is the strategic with only one real rule alteration. During combat (which is a quick process, not clumsy at all in my opinion), is unrealistic yet legal, do the following: Arrange it so that you can generate a random number, giving each ship in the fleet an equal chance at being selected. Whether this is by chits, cards, slips of paper or dice does not matter. Then for each damage factor the fleet takes as a whole, generate one number. This ship receives the damage. Generate a number for all the damage factors you are required to inflict on your fleet. Never exclude a ship from this process, unless it has been eliminated through repeated hits. In this way, ships can remain unharmed, receive minor damage, major damage (an important aspect in both fighting ability and economics), or be completely destroyed. This removes the bothersome event of ships entering combat yet all escaping relatively unharmed. It is simple, yet effective.

Lastly, I would say to take the game at face value. It has its good points and bad points, yet achieves the goals it sets upon itself. Yes, another month and \$1000 probably would have produced a 'great' game. This doesn't mean that BATTLEFLEET MARS isn't a good game- because that is exactly what it is: a good game. If you get it, play it more than once or twice, because there is a lot there. Just give it a chance.

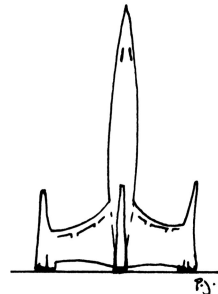

SPACE MARINES

a review

by

LYNN WILLIS

SPACE MARINES is a new, SF miniatures, ground tactical rulesbook: 72 offset pages, with extensive tables, illustrations, and examples. It owes a debt to STARGUARD, although the earlier game's elaborate figurine-painting instructions are missing, presumably because SM lacks a tie-in with a miniatures manufacturer.

A list of the game's tables will show SPACE MARINES' area of concern: Movement/Terrain, Concealment & Detection, Direct Fire Adjustment, Direct Fire Weapons, Penetration, Indirect Fire, Indirect Fire Weapons, Warheads, Vehicle Penetration, Vehicle Damage, Pre-20th Century Direct Fire, 20th Century Direct Fire, Archaic Indirect Fire, Melee, Anachronisms (e.g., what effect a neuroniac whip has against chain mail), and Morale.

There are also link modules for DUNGEONS & DRAGONS and METAMORPHOSIS ALPHA--yet another way to spice up things on level seven.

SPACE MARINES simplifies STARGUARD'S play into straight-forwardly sequential phases; SG's phases arranged a tactical thicket for the inexperienced player, approximating the effect of simultaneous movement but difficult to keep straight sometimes. Miniatures rules are not always rigorous, often being do-it-yourself kits rather than comprehensive games; Mark Ratner, the designer of SPACE MARINES, has made a special effort to spell out controversial areas like observation and detection. Whatever one may think of the realism of the various aliens and alien organizations described, they and their various human counterparts form a cookbook of possibilities which can be explored for a long time. About 150 weapons from past, present, and future are rated by capacity, ranges, rates of fire, etc., and for penetration of various natural and armored body coverings, screens, etc. (In several tables there is reference to chiton, a misspelling of chitin, as TSG readers know; a chiton is an early model underpant, bottomless, with no stopping power.)

Comment: SF miniatures translate the wider arena of WWII/contemporary miniatures. The effect of stunners and hand scramblers differ from a club or a Colt

.45 in the values of a few numbers in a table or two; science fiction flavor may come from name substitution (i.e., heavy infinite repeater for machine gun or space-cruiser for cruiser). All SF games are open to the charge and, in some way, are guilty of it, but SF tactical games are difficult to characterize (to make feel real) because their activities are elemental: movement/terrain interaction and fire capability/effect. Because of the tactical nature, politics, humanistic concerns, territorial possession, general integration into a broader spectrum of concern--all this must be missing.

SPACE MARINES presents a superior version of what we already have. ORILLA, a supplement to STARGUARD, has been published, and STARSTRIKE, another SF ground tactical rulesbook, has or will emerge. Perhaps one or the other has some basic innovations--exotic terrain and terrain effects particularly would be nice, as most actions now apparently take place in southern Missouri.

SPACE MARINES (A. Mark Ratner): \$6.00, from FanTac Games, 464 Lenox Ave., South Orange, N.J. 07079.



DEAR EDITOR,

As SC now stands, all one must do is research PFS and "build" a PFS unit on the planet to be protected. It is then impervious to attack by anything. Totally unrealistic I think, not only because no matter how powerful a planetary shield is, eventually something or someone will find a way to break it, but also because it is going to cost something to maintain a planet-sized shield. Seems to me it will take an awful lot of energy. So, in my version of SC, when one researches PFS and buys a PFS unit for one of his planets, he still doesn't have a working PFS. And his PFS will not be operable until it is "energized" -- to energize a PFS it is necessary to spend IU. For each IU spent to energize a PFS, that PFS will protect that planet from one offensive attack point from enemy ships. So, a PFS which had 20 IU spent to energize it would protect that planet from 20 points of attacking ships. (attack points for ships correspond with their ability to destroy colonists/IU, 7.2.8 in SC rulebook: esc=1, ATK=3, DN=5.) A shield must be re-energized each production interphase. I.e., that 20 point PFS above would be good for 4 game turns, after which it would have to have more IU expended on it or else the shield would collapse.

A shield is considered destroyed when more attacking points are present than there are shield points. If four DN showed up at the 20 power shield that planet would be safe and its missile bases or AMB's would get a shot at the enemy ships (which are not automatically destroyed if they attack a PFA, they simply attack it without effect if they have less attack points than the shield has defensive points...). If, on the other hand, four DN and one ESC showed up (or seven ATK's) the shield would be destroyed on the first combat fire turn. The next combat fire turn the ships could attack the planet's missile bases or AMB's, or if none, then pop/IU.

In a situation such as this, the ATK ship is superior to any other ship. To crack the 20 power shield, for example, it

would take a minimum of 4 DN & 1 ESC (IU cost of 168) or 20 ESC (IU value of 160) Attack might be less effective than the other ships, but in planetary assaults, the ATK is the ship to have.

Robert Barger
Evensville, Tn.



It has been argued--and perhaps justifiably--that wargamers are simply adults who have never outgrown their boyhood love of playing with toy soldiers. If this argument is conceded, perhaps it does much to explain the fact that in wargaming more than any other fandom there is a vicious complex of currents and cross-currents tugging away at those who embark on the stormy sea of game design.

The childish joys of playing soldier are frequently coupled with the childish-ly egocentric trait of self-interest uber alles, and much of the "will to win" I see in my kriegsspiel opponents reminds me of the attitudes abounding in preadolescents. How much of the adult wargamer's fuddling "rules funnies" are reflections of his prepubescent cries of "Fall down, you're dead!?" How much of the push for victory is a reflection of the pouting child behind the man, unwilling to retreat from his petulently-held point of contention?

In a fandom composed largely of such types, it is natural that there should be vast quantities of angst, heavily seasoned with acrimony, partisan politics and not-so-veiled threats. To couple with this a thriving business--the wargaming industry--is to set the stage for a cataclysmic exchange of suits and counter-suits regarding copyright violations, plagiarism and similar unpleasanties.

Hell, even in the area of fantasy role-playing games, where cooperation within a party of "dungeon delvers" is vital to the survival of each and every member, there is an incredible amount of backbiting. The TSR people are making an unsavory reputation for themselves in threatening lawsuits against anyone who might be infringing upon their copyrighted games. I mention pointedly their treatment of the fanzine THE DUNGEON MASTER, which still fawns upon TSR in spite of some incredibly heavy-handed attacks from "Our good friends at Lake Geneva."

In the light of my observations above, you may assume that I am reluctant to enter onto the stormy sea of game design and its attendant ulcerogenic glitches, except to offer suggestions and feedback to those hardy souls who set forth upon those rolling waters. My best wishes and 50 mg of dramamine to them; I can think of better ways to ruin my appetite.

My only reason for sending you that long letter on notions for a LORD KALVAN game was that it might perhaps be an interesting topic for a future MGC title. I have still not obtained a copy of DOWN STYPHON!, but it's my impression that the gamesystem is applicable to any struggle of the English Civil War period, and is therefore not really SF&F gaming but a deal of "what-if" stuff--another historical game.

The unique factors in the novel, the things that give it savor and make it the kind of book I read over and over again, are not reflected in such a game. Picture Lord Kalvan's problem, and his approach to its solution: he is in a strategic bind



because he opposes an enemy much larger and better-funded than he; he is surrounded and might be attacked by two or even three hostile neighbors at once; over all is the threat posed by Great King Kaiphranos, who must eventually march at Styphon's command.

How does Kalvan cope with the problem? He is not a great tactician. His performance at Tarr-Dombra, Fitra and Fyk demonstrate that his command of troops in battle is adequate, but not brilliant. His genius lies in his strategic ability more than in his battlefield charisma. At Dombra, he out-thought the defenders, tailoring the tactics of the assault to the strategy of deception that actually won the battle. At Fitra, it was the strategic consideration that dictated his victory, from the concept of the Mobile Force to his refusal to give battle at the border and thereby catch the Nostori army strung out along the road and vulnerable to defeat in detail. At Fyk, he committed strategic and tactical errors, fighting a battle of attrition rather than one of maneuver (to which the Hostigi army, as trained and equipped by Kalvan, was superbly suited). His victory at Fyk was won off the battlefield, at Tarr-Esdreth of Sask, by the cannons of Alkides, and by the blundering Balthames, whose calvary assault would have destroyed the Hostigi army had it not been for the peculiar minut the Hostigi and Saski had danced shortly before his attack.

On an "intimate" tactical level (such as that seen in DOWN STYPHON!), the real brilliance of Lord Kalvan cannot be properly demonstrated. Only on a low-strategic level can a game duplicate Cpl. Morrison's superb handling of the Hostigi problem. Unlike Napoleon, who was handed the finest army on the Continent, Kalvan had to forge his weapons before entering battle. The wars that lead to the rise of Hos-Hostigos were won in the powder-mills of Hostigos Town and in the palaces of Nyklos, Nostor, Sask, Beshta and the other princedoms cajoled, bluffed or bludgeoned into submission by promise of Kalvan's Unconsecrated and freedom from Styphon's House on Earth.

Any game that serves to duplicate the rise of Lord Kalvan of Otherwhen must include these considerations. Battles will be fought, yes, but their outcome must be, to some extent, a foregone conclusion, in that Hostigi victory can only be borne of superior weaponry and, more importantly, superior strategy.

Therefore, you may feel free to think of a HOS-HOSTIGOS game as a sort of STELLAR CONQUEST in Centre County, Pennsylvania, and go it from there.

Rich Bartucci
Larned, Kansas

There seems to be a tendency among TSG readers to polarize on the subject of computer games. I refer specifically to the little debate in the "Letters" section of TSG #12. One side maintains that computerization of intricate games isn't worth the effort. The other says its easy.

Wrong on both counts! Any event can eventually be broken down into a decision-tree (or its more popular cousin, the flow chart). Jacob Bronowski, creator of the PBS series "Civilization" was drawn into anthropol, by his attempt to mathematically describe the evolution of the human jaw; something far more subtle than any simulation game. He succeeded, depicting a truly complex system in nothing but 1's and 0's. It can be done, but in won't be easy until computers are smarter than we are.

The biggest problem in computerization of a game is memory -and its attendant cost. To properly adapt a D&D type game, you're going to need at least 16K bytes of active memory and a tape unit or floppy-disc for your text. "Behind the onyx slab is a small wooden door with a bronze plaque at eye level...", etc... I wonder how many people realize what a 16K Static RAM can cost.

There are other difficulties in digitizing a FRP game. Let's face it, D&D, PETAL THRONE and the rest are MIND games. They require the referee to stretch his creativity to the limit. With the present systems and techniques, there is no way a computer can handle that responsibility by itself. Even with the newest high-density memories, a computer ranks somewhere between junebugs and sagebrush when it comes to native intelligence.

The one place a computer really outshines a human ref is in the subbookkeeping department. Anyone who's tried to juggle 6 player characters, 8 non-players, and an assortment of monsters, spells, eye, gods... Well, you get the idea.

What computers are best at is handling vast amounts of information in a repetitive manner. They can keep track of each player's possessions, experience points, etc.. Combat situations go from tedious exercises in arithmetic to the deadly ballets we all seek. Randomly encountered beings can be generated in seconds, leaving the ref free to deal with subtleties of character. As a tool, the computer can be invaluable. As a surrogate referee, it stinks.

With a computer at his/her side, a FRP referee can carry the players to a new level of fantasy. To paraphrase a quote I read somewhere; try computerizing MONSTERS! MONSTERS! or TUNNELS & TROLLS sometime. You'll like it.

Scot F. Bayless
Barksdale AFB, L.A.

Keep the microgames coming, I love them. CHITIN I is really a little too long to qualify as a microgame, but MELEE and OGRE are just right. My job, I am a youth pastor, prohibits me from spending hours and hours on a game, as much as I might like to. Microgames fill a real need.

I love MELEE. My friends and I have quit playing D&D because we have found that the rules are really inadequate for fair refereeing. If the whole FANTASY TRIP equals the quality and logic displayed in MELEE, I will be one really grateful gamer.

Lastly, I really appreciate the high quality of your magazine. In my opinion, it has the Dragon beat in almost every respect.

In Space Gamer #12 you mentioned the need for feedback on changing the ORGE rules, and re-publishing it with a full color cover. Yes to both.

Mark Cummings
Rockford, Ill.

Your FANTASY TRIP system is the best news I've heard in months. The tactical modules in TUNNELS AND TROLLS and DUNGEONS AND DRAGONS were very makeshift, while the tactical combat in GLADIATORS, EN GARDE, and SWORDPLAY was too limited in concept. As well, none of these games outlined campaign universes to the point of playability. (Even the D&D Game Kit, PALACE OF THE VAMPIRE QUEEN, was only a standard dungeon less imaginative than I've done myself.) I hope your system exceeds my expectations. EG. RED MOON AND WHITE BEAR would make a good strategic universe for D&D.

I promised myself I wouldn't write and explain what I meant about Computer Opponents in TSG #9. I lied. I was talking about people who play computer-modernated games; not about playing against a machine. Paranoid as it may seem, I know that playing against a computer is more demanding than playing a mere human. Withing the limits of a game structure, a machine can be programmed to make correct decisions within the programmer's ability to visualize game strategies; in some heuristic models, the machine outplays its creators. I believe that a CHECKERS program exists which is better than the world's champions in the game. The reasons for this proficiency are simple; The machine never forgets; it never gets tired; it cannot be harrassed; and, within limits, it never makes silly mistakes. However, a computer is not needed to beat a player; even a well-designed set of solitaire rules can do this. SPI's OPERATION OLYMPIC is an example of this. By use of a simple, non-random movement sys-

tem, the rule moderated Japanese side can put up an appallingly effective defense; better than when a live opponent takes the part.

And I still say you can't computerize STRATEGY I. With 1120 counters, a continent-sized map with 50-mile hexes, rules for land, sea, air environment and combat, position-specific production rules involving differentiation by technological level, not to mention six input factors, the game is almost unplayable in face-to-face situations, let alone play-by-mail. It would take longer for a Computer to moderate STRATEGY I by mail than it would take a human referee to play it.

The writer who reviewed BATTLEFLEET MARS was disappointed by the semi-abstract movement system. In contrast, I'm quite impressed, though I've only looked at a friend's copy. The system minimizes the waste space devoted to maps, as the only use of a strategic map is for movement. Graphically, it could be simulated by a system similar to TRIPLANETARY, with movement of planets and fixed-thrust ion engines. You accelerate continuously to midpoint, flip over, and decelerate the rest of the way. Thus, the 3-month voyages on the distance chart are much longer than 3 1-month trips. Concerning the 4-month trip box: A player who changes destination partway through a voyage must also allow deceleration time. If you're 2 months out on a 3-month trip, and want to go home again, it will take you 4 months to do it. I like the concept.

LANKHMAR'S quite a good game, except the counter stacks keep falling over. TSR's not very experienced at regular board games, it would seem. STAR EMPIRES is a wonderful experience, once a referee has dug in to it and found the bugs; I'm presently starting a full scale campaign with 34 starfaring species (everyone starts as a Minor Empire.) Now all I need are 31 more players...

How sad that you're dropping your line of other-publishers' F&SF games, though I can appreciate your sentiments. A friend of mine asked me about a new company, and was worried that he'd receive nothing for his money. Many gamers have been stung by Taurus Games, and fear a repetition. At least a player knows he'll get something when a reputable firm sells a competitor's product, even if it's only a refund.

Norman S. Howe
Winnipeg, Manitoba

I recently purchased your game Chitin: I. I find it an excellent suitable game. I would like to suggest two minor additions to the rules for clarification.

7.066 Retreat. ...The facing of a retreated stack is not changed.

8.036 Attacking out of Command Control. Units out of command control during both the Movement and Combat Phases may attack adjacent enemy units at disrupted strength if they did not move during the friendly movement phase. They may not advance after combat.

These two rules should reduce hassles somewhat.

Martin J. Joyce
Yonkers, N.Y.

I first played a Metagame a few weeks back. It was Ogre, which I enjoyed very much. I decided to send for a copy of the Space Gamer and your catalog.

It arrived a few days ago, and I would like to say that I have never had so much enjoyment reading a gaming magazine. I subscribe to two other gaming zines and have access to another, but none deal with the material you do - strictly SF&Fantasy games. I have 41 games, and most of my favorites deal with these subjects. There are many magazine articles on present-day and historical warfare, but not many on SF and even fewer on Fantasy games. After 15 minutes of TSG 11, I had decided to get it.

After I had finished the copy of TSG, I spent over three hours reading, re-reading, and selecting games from your catalog. It's been a long time since I have spent a more enjoyable evening, and I am looking forward to: my future issues of TSG, Monsters! Monsters!, Chitin: I, and Stellar Conquest.

John Schuerger
Mechanicsburg, Pa.

NEXT ISSUE _____

Robert Taylor introduces RIVETS with some very special art, more 'Absolute Zero', Bill Williams' THE MASTER'S GAME, more about OGREs, reviews of ALL THE WORLD'S MONSTERS, TROY, and many more...

HOW ABOUT A \$2.95 QUICKIE?

Metagaming's MicroGames are small, fast-playing, and inexpensive. But not trivial. A MicroGame is a classic war-game...that you can put in your pocket and play over lunch.

Each MicroGame includes a rulebook, an 8¼" by 14" (or larger) game map, and 42 to 112 counters.

More play for less money? Play a MicroGame and see.

MicroGame 1...

Your instruments pick it up ten kilometers away...and you know you're in trouble. It's 30 meters long. It has guns, missiles, armor. It's as smart as a man. And it's coming to kill you.

OGRE is a tactical game set in a future where antimissile technology has made armor vehicles practical again. Hovercraft, tanks, and powered infantry slug it out with tactical nuclear devices. But the most feared weapon of all needs no human guidance. It's the giant cybernetic tank called the Ogre.

SF fans and WWII experts alike will enjoy this fast-moving game of man versus supertank.

OGRE



Game design by Steve Jackson;
illustrated by Winchell Chung

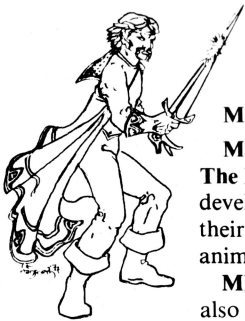

MicroGame 3...

MELEE

Man-to-man combat with archaic weapons...from The Fantasy Trip. ©

MELEE is a tactical abstract from the ultimate in role-playing games... **The Fantasy Trip.** It's the most detailed simulation of single combat yet developed. Players create fighters, set their strength and dexterity, choose their weapons and armor, and send them into the arena against human, animal, or monstrous opponents. Victors build their skill; losers die.

MELEE can be used as a tactical supplement to any fantasy game. It will also interest any student of history. You can play out small-scale affrays in any period...against an opponent, or solitaire.

Game design by Steve Jackson;
illustrated by Liz Danforth

\$2.95 each

*\$2.50 for subscribers
to The Space Gamer.*

METAGAMING

**Box 15346
Austin, Texas 78761**

THE RETURN OF THE \$2.95 QUICKIE

Metagaming's MicroGames are small, fast-playing, and inexpensive. But not trivial. A MicroGame is a classic war-game...that you can put in your pocket and play over lunch.

Each MicroGame includes a rulebook, an 8¼" by 14" (or larger) game map, and 42 to 112 counters.

More play for less money? Play a MicroGame and see.



MicroGame 2...

CHITIN: I THE HARVEST WARS

Game design by Howard Thompson;
illustrated by Paul Jaquays

Chitin is a tactical version of Metagaming's upcoming *Hymenoptera*. Intelligent insects war for space and food, breeding ever-more-fearsome warriors. The objective is to bring back Harvest Chits — or enemy bodies.

• The Hive must eat...

Call it summer. There are seven seasons on this world...but now is the time of harvest. The dun-colored workers leave the hive, moving into the valleys to gather the crops.

But other hives want those crops, too. A horde of gleaming fighters — spiked travesties of the busy workers — tears into their midst. Then the counterattack comes, and warriors rend warriors. The small, spidery commanders are as careless of their own lives as they are of their soldiers'. Losing a few units doesn't matter. Nothing matters except victory, and the food victory brings. No quarter will be asked, and none can be given. It is the time of the Harvest Wars.

MicroGame 4...

WARPWAR

WARPWAR is a game of interstellar maneuver and tactical combat. The players design their own ships, giving each its own offensive, defensive, and movement capability. Ships move through space — or jump along the warplines that connect certain stars — to gain control of enemy base stars.

WARPWAR uses a unique *diceless* combat system. When ships clash, each player selects movement and combat power allocations for

each of his units. Cross-reference determines what damage is done to each ship. No chance is involved...you must *outguess* your enemy.

Advanced rules introduce "system ships" which cannot move from star to star unless carried by a warp ship — but are cheaper to build — and a "technology" factor which gives newer ships an advantage in combat.

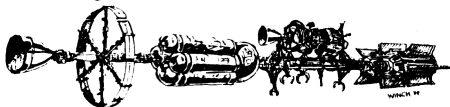

Game design by Howard Thompson;
illustrated by Winchell Chung



Metagaming's MicroGames

\$2.95 each

\$2.50 for subscribers to The Space Gamer.

Coming up: Rivets, Wizard, and Erehwon.

METAGAMING

Box 15346
Austin, Texas 78761